

Toolspress high quality tooling systems

System Trumpf-Wila

System Bystronic

System LVD

System Colly

tools  press

Trumpf-Wila • Bystronic • LVD • Colly

Press Brake Tooling & Accessories

Version - 1.1

www.toolspress.com

toolspress
Press Brake Tooling & Accessories

Versione Italiana  English version 

Toolspress srl - Via Argini, 23 - 43037 S. Maria Del Piano Parma - Italy
Tel. +39 0521 850510 / 850677 - Fax +39 0521 850796

toolspress
Press Brake Tooling & Accessories

Home Company Products Where we are Download Catalogue Contact

WELCOME

toolspress has been established in 1984 by Mr. Ben. Ferraresi, with over 40 years' experience and expertise in the design and production of high quality, precision ground press brake tooling and accessories. The company's success is based on its commitment to innovation, research and development, and its ability to provide a complete range of products and services to its customers. The company's products are used in a wide range of industries, from automotive to aerospace, and its reputation for quality and reliability is well known throughout the world.

History
Technology
Establishment
Quality

toolspress
Press Brake Tooling & Accessories

System Colly

Home Company Products Where we are Download Catalogue Contact

NOTRE TOOLSPRESS

Del 1984, Ferraresi Systems Europe sono associati con le migliori qualità di ricerca e sviluppo per continuare a migliorare la qualità. L'obiettivo è quello di produrre che gli utenti, con un prezzo molto chiaro e preciso. È il primo e principale punto di riferimento del cliente, aumentando di anno in anno la gamma di prodotti, con una continua ricerca e sviluppo nel campo della ricerca e sviluppo. Per il futuro azienda. Del 1984 Ferraresi Systems Europe produceva press brake tooling and accessories, and other high precision ground tooling. Today the company is a leading manufacturer of high precision ground tooling and accessories, and is known throughout the world for its quality and reliability. The company's products are used in a wide range of industries, from automotive to aerospace, and its reputation for quality and reliability is well known throughout the world.

System Colly
System Colly
System Colly

toolspress
Press Brake Tooling & Accessories

TOOLSPRESS SYSTEM

Home Company Products Where we are Download Catalogue Contact

TOOLSPRESS SYSTEM

Ferraresi Systems Europe sono associati con le migliori qualità di ricerca e sviluppo per continuare a migliorare la qualità. L'obiettivo è quello di produrre che gli utenti, con un prezzo molto chiaro e preciso. È il primo e principale punto di riferimento del cliente, aumentando di anno in anno la gamma di prodotti, con una continua ricerca e sviluppo nel campo della ricerca e sviluppo. Per il futuro azienda. Del 1984 Ferraresi Systems Europe produceva press brake tooling and accessories, and other high precision ground tooling. Today the company is a leading manufacturer of high precision ground tooling and accessories, and is known throughout the world for its quality and reliability. The company's products are used in a wide range of industries, from automotive to aerospace, and its reputation for quality and reliability is well known throughout the world.

TOOLSPRESS SYSTEM

Collegandovi al sito www.toolspress.com avrete accesso in modo dettagliato alle informazioni tecniche di tutti i prodotti Toolspress. Direttamente dal sito avete la possibilità di scaricare tutti i cataloghi dei nostri prodotti.

Simply click www.toolspress.com and have total access to detailed and technical information of all Toolspress products. We have created for your convenience the availability to download the brochures of our products.

Klicken Sie auf www.toolspress.com und Sie haben Zugang zu ausführlichen und technischen Informationen über alle Toolspress® Produkte. Sie haben die Möglichkeit alle Toolspress Werkzeugprofile als die kataloge unsere produkte.

toolspress
Press Brake Tooling & Accessories

Toolspress tooling system

European Style Tooling

- La linea di utensili di precisione per presse piegatrici più vasta al mondo.
- The largest precision ground press brake tooling line in the world.
- Das weltweit größte Werkzeugprogramm an geschliffenen, präzisen Abkantwerkzeuge.

SmartClamp

- Il rivoluzionario sistema di bloccaggio per utensil European Style al mondo.
- The revolutionary quick-release Clamping System for European Style tooling in the world.
- Das weltweit genaueste, zeitsparendste Werkzeugspannsystem für European Typ Werkzeuge.

SmartClamp

Sistema di bloccaggio a spruzzo brevettato.

La comodità in un semplice click

toolspress
Press Brake Tooling & Accessories



- Tutti i nostri prodotti sono marchiati con questo logo e forniti con una confezione sicura e di qualità.
- All our products are marked with this logo and supplied with a safety and quality packaging.
- Alle Toolspress Werkzeuge erkennen Sie an diesem Logo. Sie werden in einer stabilen und sicheren Verpackung geliefert.

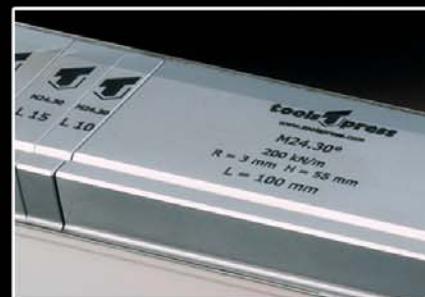

Utensili di precisione Toolspress Stile BYSTRONIC® - TRUMPF® - LVD® - COLLY® - per presse piegatrici.

Le nuove linee Beyeler® - Trumpf® - LVD® - Colly® sono prodotte con la qualità di acciaio legato che garantisce il più elevato grado di qualità nel rispetto delle tolleranze per incontrare e superare le aspettative nella richiesta di piegatura. Offriamo il grado di tolleranza più elevato nel settore, +/- 0.01 mm. Gli utensili TOOLSPRESS si allineano perfettamente garantendo anche rapidità nel cambio utensili e per elevata ripetibilità di allineamento oggi e per futuri acquisti di nuovi utensili. In aggiunta, tutti gli TOOLSPRESS sono marchiati al laser con il numero del codice, informazioni tecniche per una facile e rapida identificazione. In definitiva, gli utensili TOOLSPRESS sono prodotti con la massima qualità, precisione e cura offrendo le migliori soluzioni per le vostre necessità di piegatura.

"HR" STYLE TOOLING

Toolspress è felice di introdurre le nuove linee di utensili temprati Beyeler® - Trumpf® - LVD® - Colly® per incontrare le richieste dei piegatori di lamiera che necessitano massime potenzialità nella piegatura. Toolspress offre le migliori soluzioni del mercato mondiale per incontrare le richieste di durata, affidabilità e ripetibilità delle tolleranze, offrendo la serie chiamata "HR", cioè ad Alta Resistenza. La serie "HR" ha le seguenti caratteristiche standard:

- Acciaio legato 42CrMo4, bonificato a 30 HRC.
- Tempra ad induzione a CNC con profondità di 4mm su tutte le superfici di lavoro ad una durezza di 58 HRC.
- Prodotti disponibili per consegne rapide.
- E' disponibile il trattamento di Nitruazione QPQ Tenifer con durezza superficiale di 64 HRC.
- Possiamo eseguire ogni tipo di modifica.
- Tutti i Punzoni Trumpf® sono forniti standard con le spine fisse per la sicurezza anticaduta.

Oltre a tutto questo gli Utensili Speciali sono la nostra specialità. Toolspress progetta soluzioni per ridurre i tempi di piazzamento e aumentare la produttività.

BYSTRONIC® - TRUMPF® - LVD® - COLLY® - Style Precision Ground Sectionalized Press Brake Tooling from Toolspress.

The new Beyeler® - Trumpf® - LVD® - Colly® lines are manufactured with the highest quality materials and exacting tolerances to meet and exceed the demands of forming. Offering the highest tolerances of +/- 0.01 mm. The TOOLSPRESS tooling aligns sectional tools precisely and maximizes tooling changeovers with repeatable interchangeability today and when future tooling is purchased. In addition, all TOOLSPRESS tooling is laser marked with part number, information and piece dimension for easy and quick identification. Furthermore, TOOLSPRESS tooling manufactured with the highest quality, precision and care providing the best solution to solve your fabricating needs.

"HR" STYLE TOOLING

Toolspress is excited to introduce the new range of Beyeler® - Trumpf® - LVD® - Colly® tooling hardness to meet the demands of fabricators who demand the maximum potential for forming. Toolspress offers the best solution in the world market to meet the demands of longevity, durability and exacting tolerances called "HR" means High Resistance. "HR" has the following standard specifications:

- 42CrMo4 Premium tool steel, Hardening and Tempering throughout to Rockwell 30 HRC.
- CNC Deep hardened at 4mm deep on all working surfaces to Rockwell 58 HRC.
- Items stocked for immediate delivery.
- Black Nitride hardening is available to 64 HRC.
- Modifications available.
- All Trumpf Punches are provided standard with the fixed pins for safety.

Additionally, specials are our specialty. Toolspress engineers tooling solutions to reduce setup time and increase productivity.

BYSTRONIC® - TRUMPF® - LVD® - COLLY® - Serie von TOOLSPRESS; Präzisionsgeschliffene, sektionierte Abkantwerkzeuge.

Die Abkantwerkzeuge der neuen Beyeler® - Trumpf® - LVD® - Colly® Serie werden aus hochwertigem Vergütungsstahl, unter Einhaltung sehr enger Toleranzen, hergestellt, um die hohen Marktanforderungen an Abkantwerkzeuge zu erfüllen und zu übertreffen. Die Toleranzen der TOOLSPRESS Werkzeuge betragen +/- 0.01 mm. Durch die hohe Präzision der TOOLSPRESS Werkzeuge passen die sektionierten Werkzeuge perfekt zueinander. Die Austauschbarkeit, bei heutigen und zukünftigen Werkzeugen, wird dadurch gewährleistet. Zur leichteren und schnelleren Identifikation sind alle TOOLSPRESS Werkzeuge laserbeschriftet mit Teile-Nummer, technische Daten und Abmessungen. Selbstverständlich werden alle Abkantwerkzeuge mit der höchsten Fertigungsqualität, Genauigkeit und Sorgfalt hergestellt, die erforderlich ist, um Ihren Anforderungen gerecht zu werden.

"HR"-SERIE ABKANTWERKZEUGE

TOOLSPRESS ist erfreut, Sie mit der neuen "HR"-Serie für Beyeler® - Trumpf® - LVD® - Colly® Typ Abkantwerkzeuge bekanntzumachen. Die Serie wurde entwickelt, um die Anforderungen der Anwender zu erfüllen, die das maximal Mögliche für Abkantwerkzeuge fordern. TOOLSPRESS bietet mit der "HR"-Serie weltweit die beste Lösung an, um die Anforderungen der Kunden an Langlebigkeit, Standfestigkeit und anspruchsvolle Toleranzen zu erfüllen. "HR" steht für hohe Festigkeit.

Die "HR"-Serie hat folgende Standardspezifikationen:

- 42CrMo4 Vergütungsstahl, vergütet auf 30 HRC.
- CNC Härtung mit einer Tiefe von 4 mm, alle Arbeitsflächen gehärtet auf 58 HRC.
- Großes Lager für eine schnelle und prompte Lieferung.
- Nitrierhärtung auf 64 HRC möglich.
- Modifikationen sind kurzfristig möglich.
- Alle Stempel der Trumpf(r) sind mit den üblichen Sicherheitsstiften versehen.

Hinzugefügt sei noch „Specials sind unsere Spezialität“. TOOLSPRESS entwickelt Werkzeuglösungen, die Rüstzeiten reduzieren und die Produktivität steigern.



Punzoni - Punches - Stempel (System Bystronic)



- Il nuovo processo di tempra profonda a CNC, è oggi disponibile con profondità minima di 4mm e durezza fino a 58HRC.
- The new CNC-Deephardening process, it is now able to consistently harden to Rockwell 58C at depth of 4mm.
- CNC-Deephardening ist ein Härtingsverfahren das neulich von Toolspress worden ist für Anwendung bei Abkantwerkzeugen.

Bystronic R

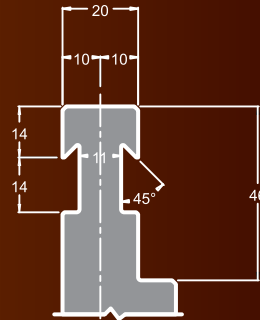

Bystronic RFA

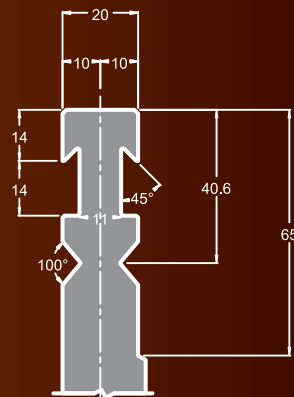

Acciaio 42CrMo4 bonificato a 23-28 Hrc
42CrMo4 Steel Hard. & Temp. to Hrc 23-28
42CrMo4 Stahl Vergütet auf Hrc 23-28

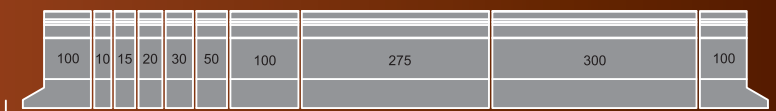
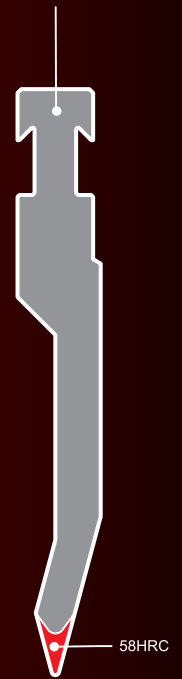

Basic segment 1000 mm

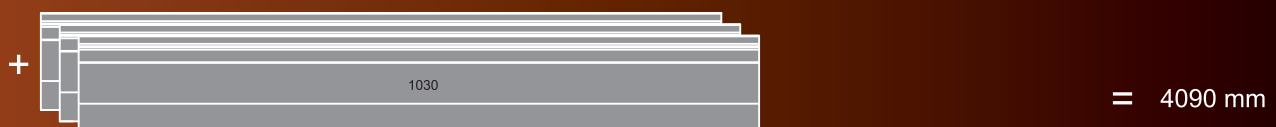
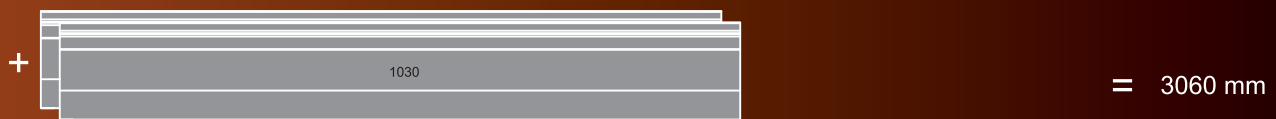
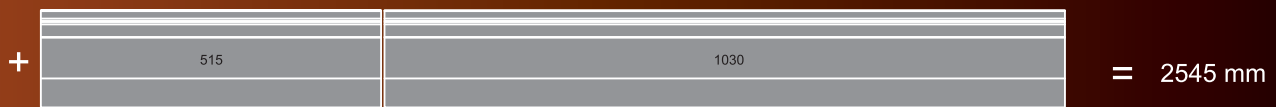
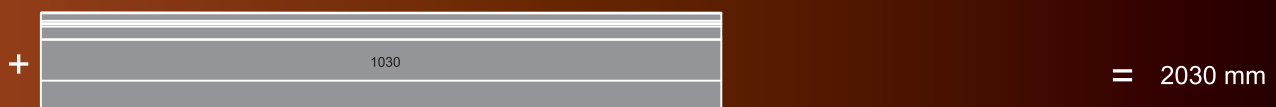

Punzoni - Punches - Stempel (System Bystronic)

P2R. 88°
P2R. 85° max F kN/m
1300

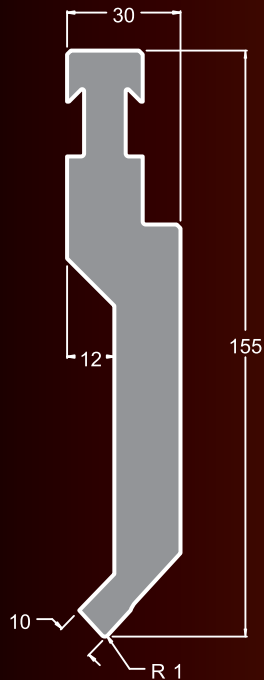

P4R. 88°
P4R. 85° max F kN/m
900

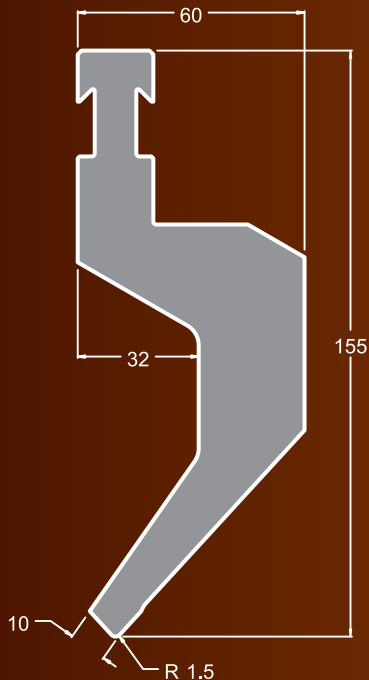

P4R. 88°
P4R. 85° max F kN/m
900

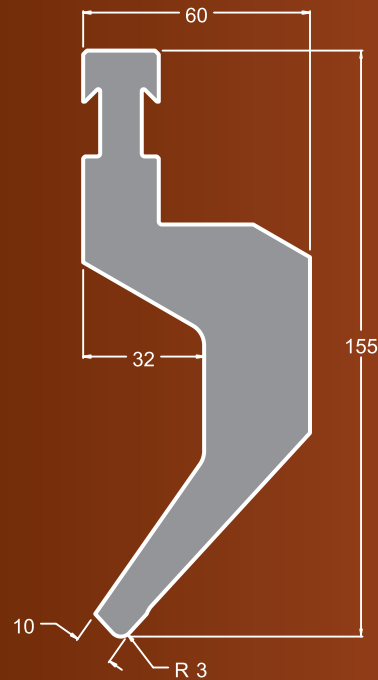

P5R. 30° max F kN/m
1000

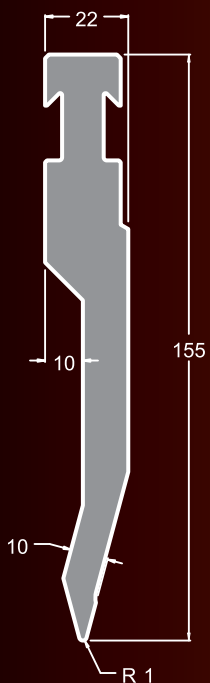

P5R. 30° max F kN/m
1000

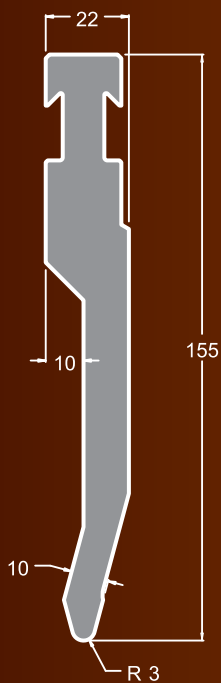

P6R. 30° max F kN/m
1600

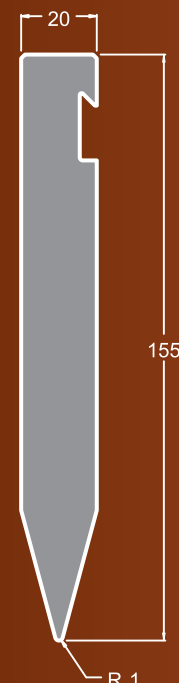

Punzoni - Punches - Stempel (System Bystronic)

P7R. 30° max F kN/m
1600

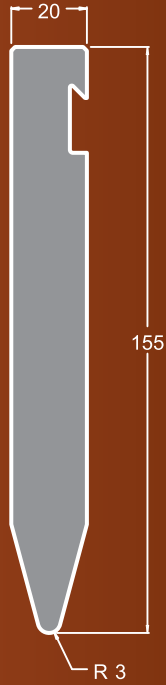

P8R. 88°
P8R. 85° max F kN/m
1000

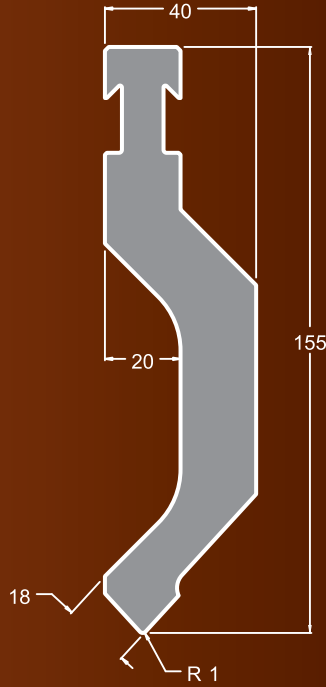

P9R. 60° max F kN/m
1600

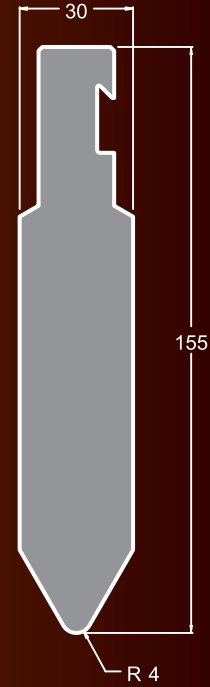

P10R max F kN/m
1000

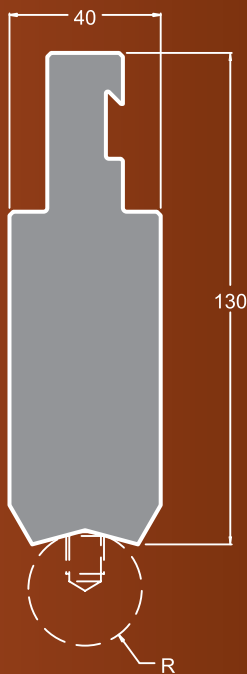

R
14
17.5
20
22.5
25
27.5
30
32.5
35
40

P11R max F kN/m
1600

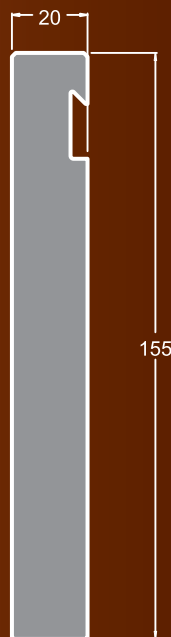

P12R max F kN/m
1600

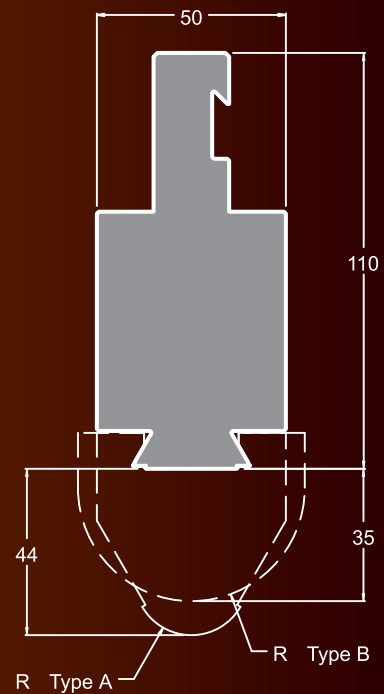

Type A

R
6
8
10
12
15
20

Type B

R
25
30
35

Punzoni - Punches - Stempel (System Bystronic)

P2RFA. 88
P2RFA. 85 max F kN/m
1300

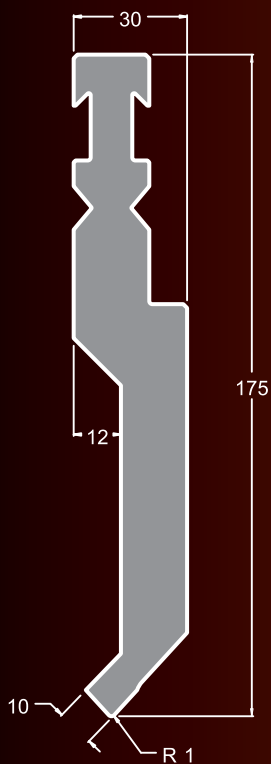

P4RFA. 85°
P4RFA. 85° max F kN/m
900

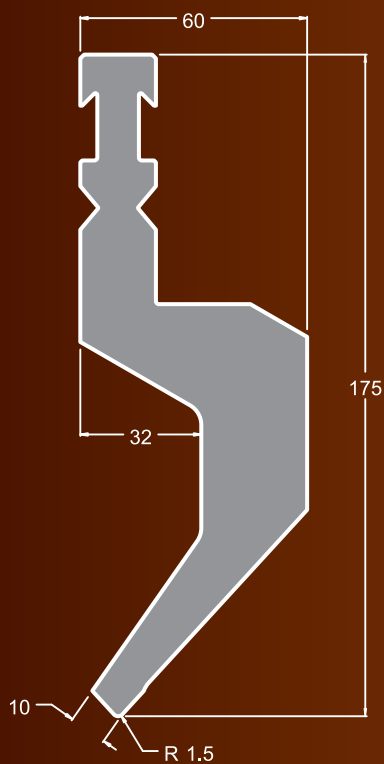

P4RFA. 85°
P4RFA. 85° max F kN/m
900

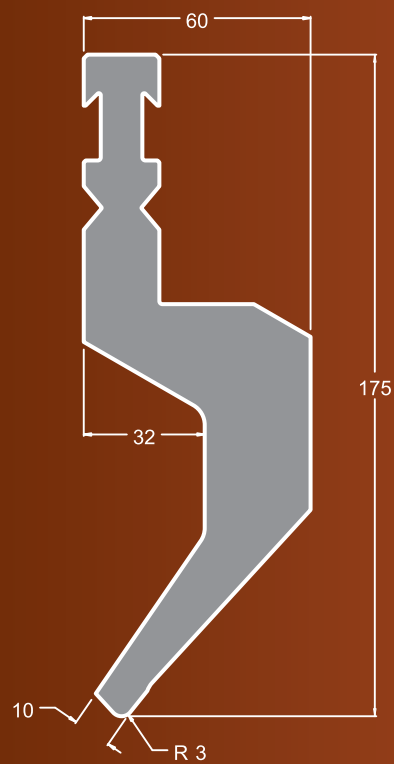

P5RFA. 30° max F kN/m
1000

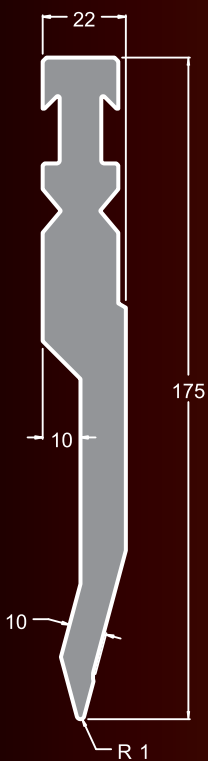

P5RFA. 30° max F kN/m
1000

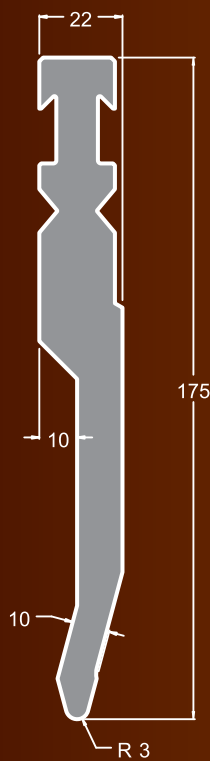

P6RFA. 30° max F kN/m
1600

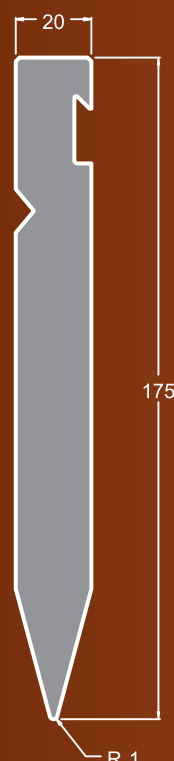

Punzoni - Punches - Stempel (System Bystronic)

P7RFA. 30° max F kN/m
1600

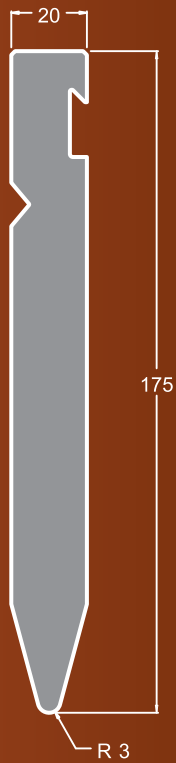

P8RFA. 88°
P8RFA. 85° max F kN/m
1000

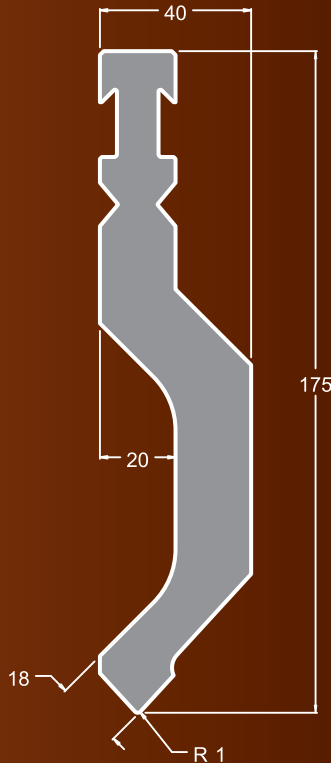

P9RFA. 60° max F kN/m
1600

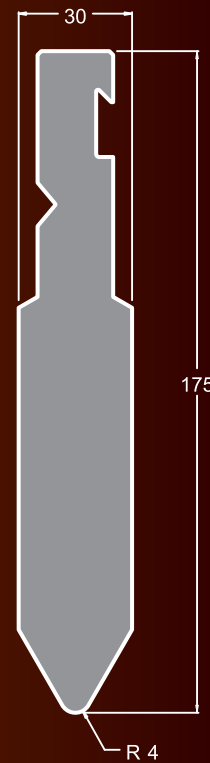

P10RFA max F kN/m
1000

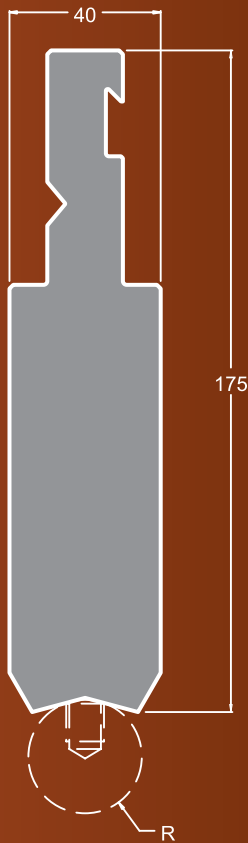

R
14
17.5
20
22.5
25
27.5
30
32.5
35
40

P11RFA max F kN/m
1600

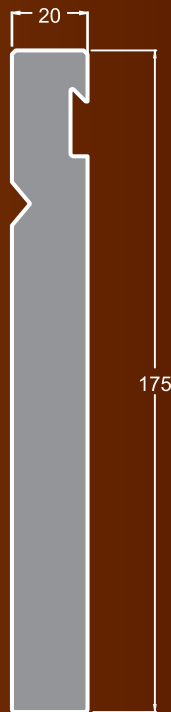

P12RFA max F kN/m
1600

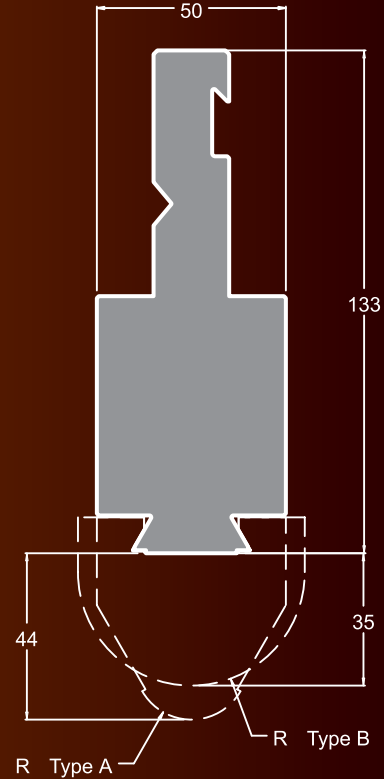

Type A

R
6
8
10
12
15
20

Type B

R
25
30
35

Punzoni - Punches - Stempel (System Bystronic)

P2RFA. 88°
P2RFA. 85° max F kN/m
1000

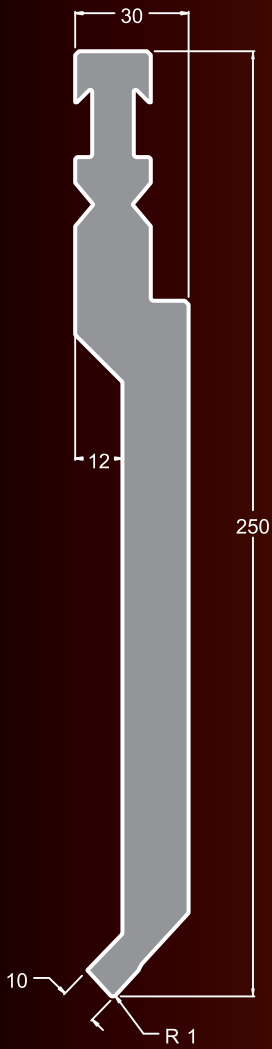

P4RFA. 88°
P4RFA. 85° max F kN/m
600

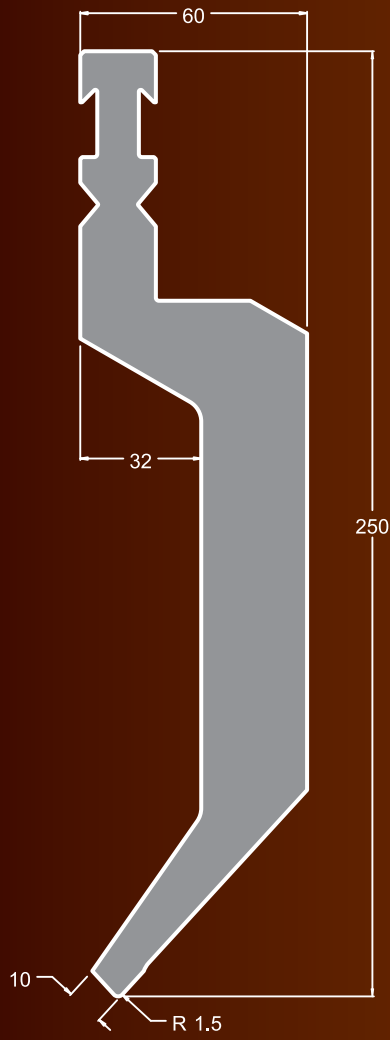

P5RFA. 30° max F kN/m
750

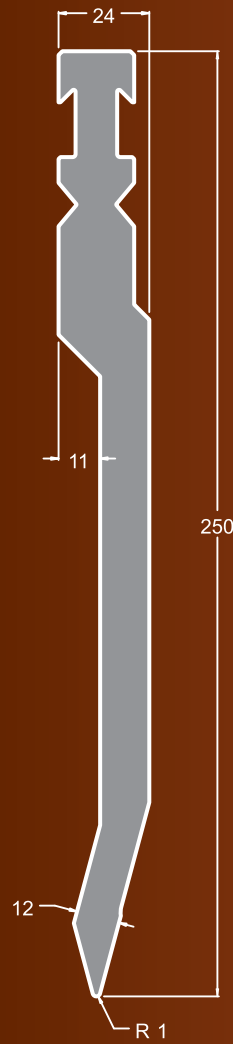

P6RFA. 30° R 1
P7RFA. 30° R 3 max F kN/m
1400

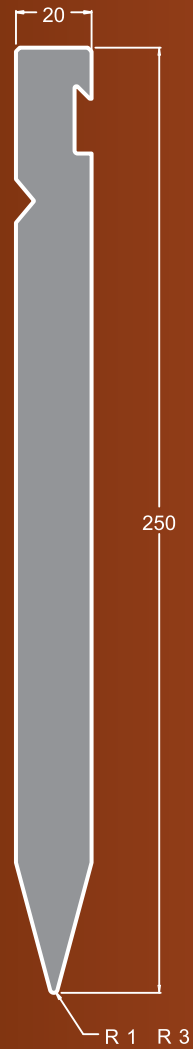

Punzoni - Punches - Stempel (System Bystronic)

P9RFA, 30° max F kN/m
1600

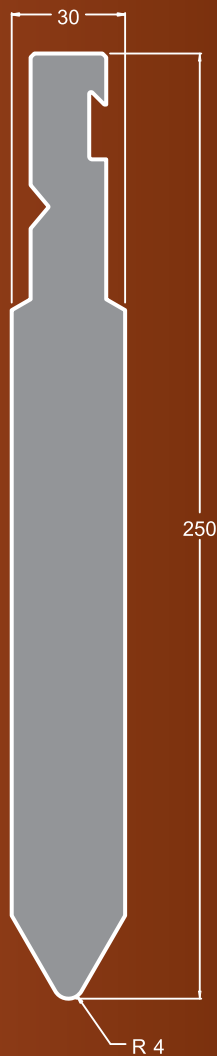

P10RFA max F kN/m
1000

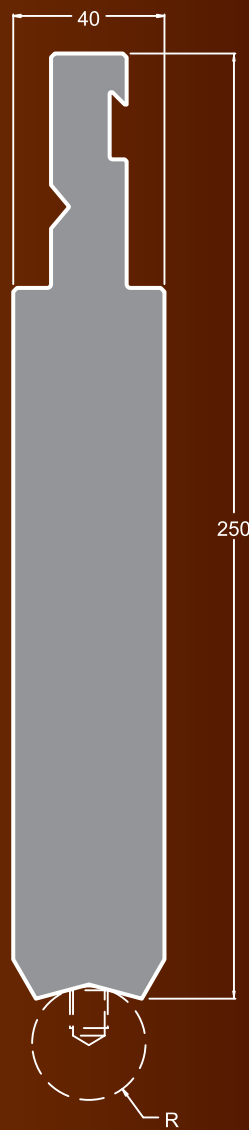

R
14
17.5
20
22.5
25
27.5
30
32.5
35
40

P11RFA max F kN/m
1600

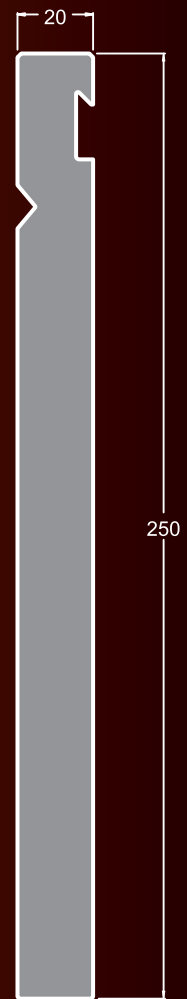

Punzoni - Punches - Stempel (System Bystronic)

PV906R. 30°
PV906RFA. 30° max F kN/m
600

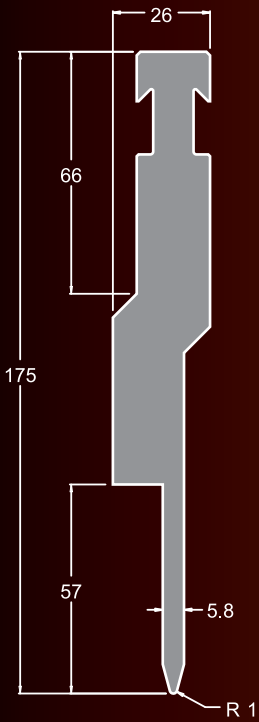

PV908R. 30°
PV908RFA. 30° max F kN/m
600

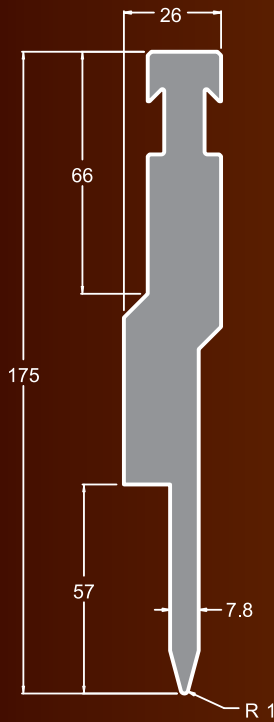

PV910R. 30°
PV910RFA. 30° max F kN/m
600

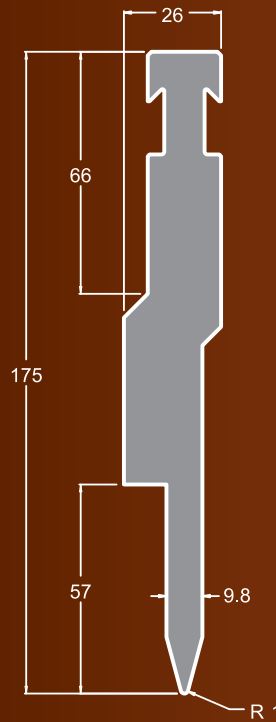

PV912R. 30°
PV912RFA. 30° max F kN/m
600

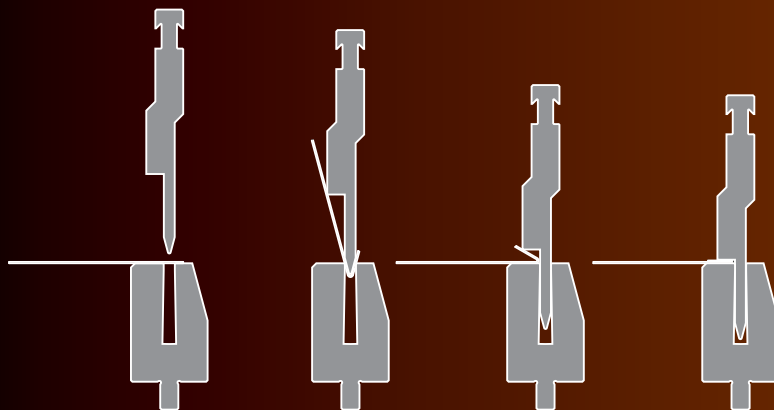
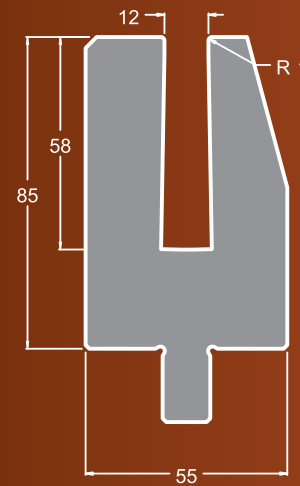
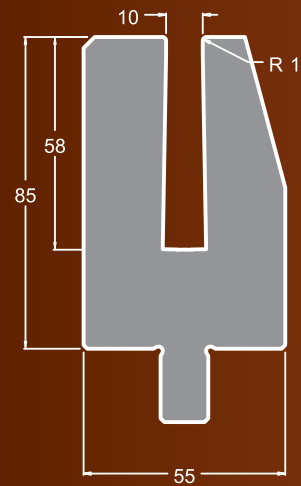
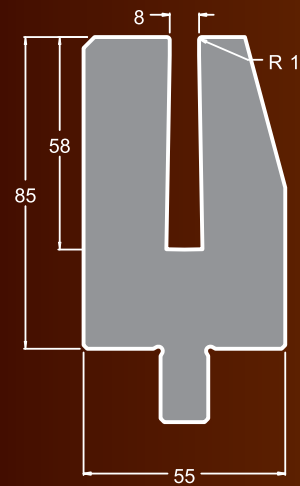
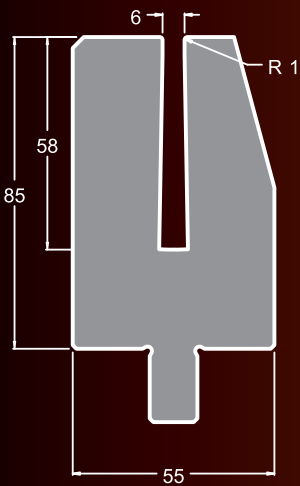
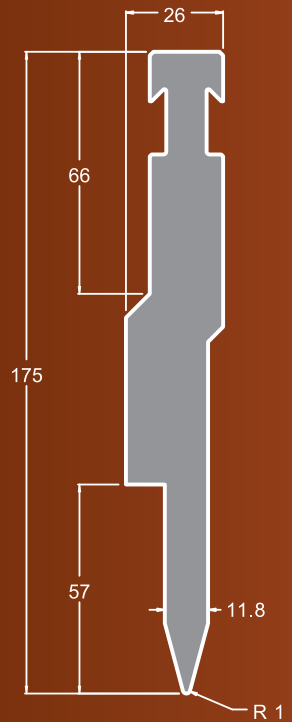

S	t/m	C	t/m	D
0.6	9	3.0	32	1.2
0.8	13	3.0	34	1.6
1.0	15	3.5	36	2.0
1.2	18	3.5	46	2.4
1.6	24	3.5	48	3.2
2.0	42	4.5	52	4.0

Matrici - Dies - Matrizen (System Bystronic)

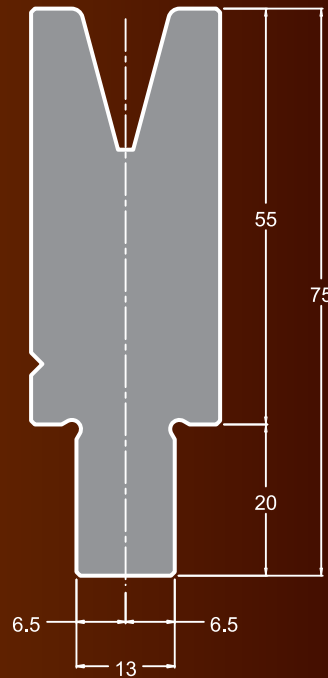

Acciaio 42CrMo4 bonificato a 23-28 Hrc
42CrMo4 Steel Hard. & Temp. to Hrc 23-28
42CrMo4 Stahl Vergutet auf Hrc 23-28

- Il nuovo processo di tempra profonda a CNC, è oggi disponibile con profondità minima di 4mm e durezza fino a 58HRC.
- The new CNC-Deeaphardening process, it is now able to consistently harden to Rockwell 58C at depth of 4mm.
- CNC-Deeaphardening ist ein Härtingsverfahren das neulich von Toolspres worden ist für Anwendung bei Abkantwerkzeugen.



Basic segment 1000 mm

+  = 2030 mm

+  = 2545 mm

+  = 3060 mm

+  = 4090 mm

Matrici - Dies - Matrizen (System Bystronic)

M6. 30° max F kN/m
90°= 900
60°= 600
30°= 400

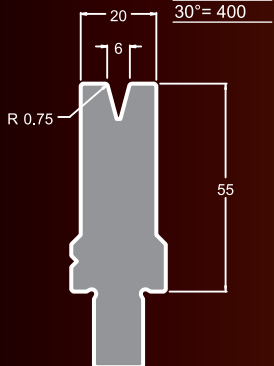

M6S. 30° max F kN/m
90°= 900
60°= 600
30°= 400

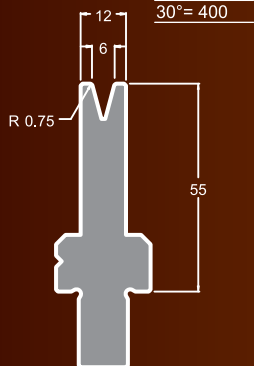

M8. 30° max F kN/m
90°= 800
60°= 400
30°= 200

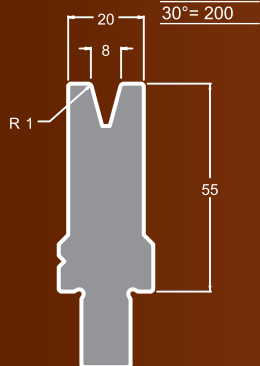

M8S. 30° max F kN/m
90°= 800
60°= 400
30°= 200

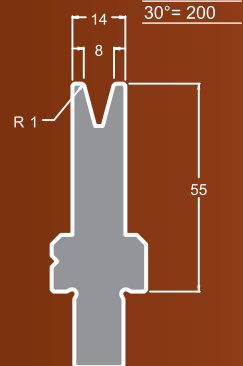

M10. 30° max F kN/m
90°= 700
60°= 400
30°= 150

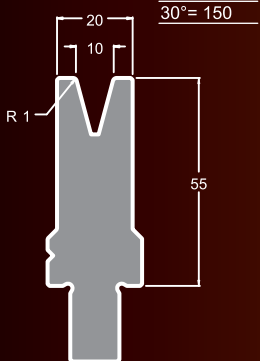

M10S. 30° max F kN/m
90°= 700
60°= 400
30°= 150

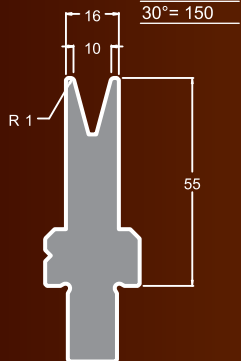

M12. 30° max F kN/m
90°= 700
60°= 420
30°= 200

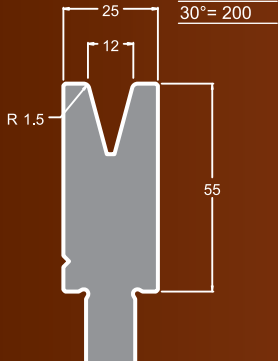

M12S. 30° max F kN/m
90°= 700
60°= 420
30°= 200

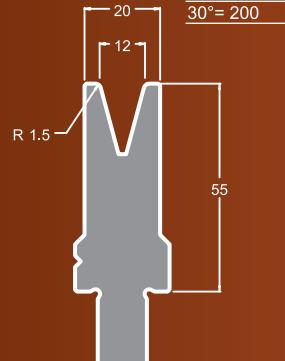

M16. 30° max F kN/m
90°= 900
60°= 550
30°= 200

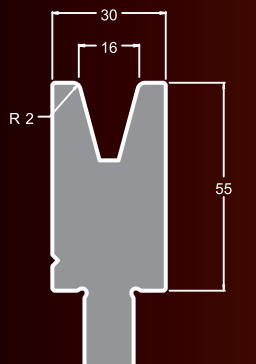

M20. 30° max F kN/m
90°= 950
60°= 600
30°= 200

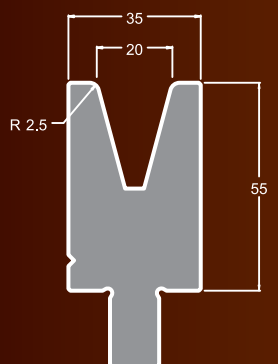

M24. 30° max F kN/m
90°= 1000
60°= 600
30°= 200

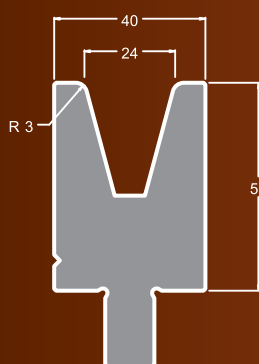

M32. 30° max F kN/m
90°= 1500
60°= 700
30°= 500

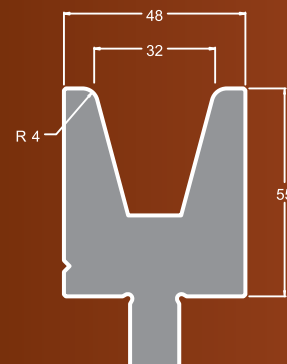

Matrici - Dies - Matrizen (System Bystronic)

M40. 60° max F kN/m
90°= 1600
60°= 1300

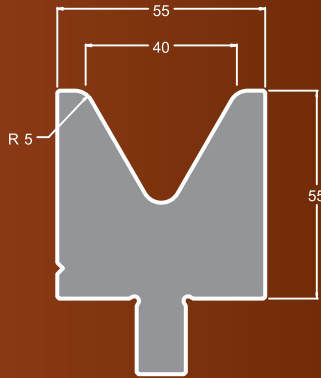

M50. 60° max F kN/m
90°= 1700
60°= 1200

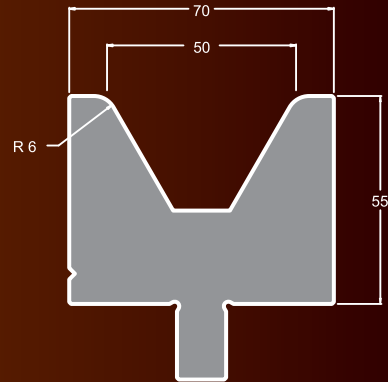

M60. 60° max F kN/m
90°= 1800
60°= 1100

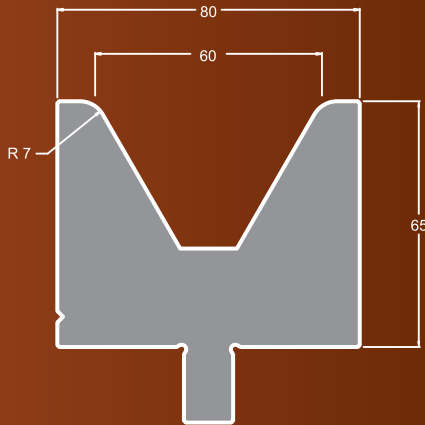

M80. 80° max F kN/m
90°= 1700

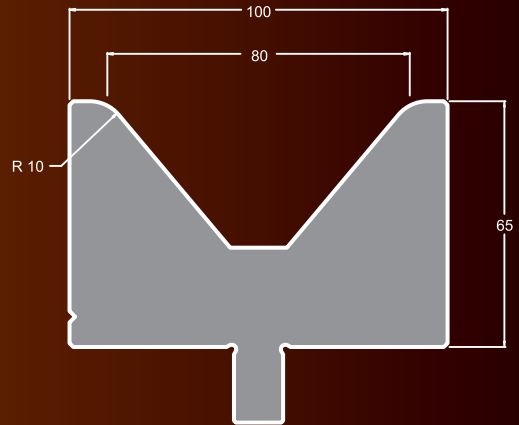

M100. 80° max F kN/m
90°= 2300

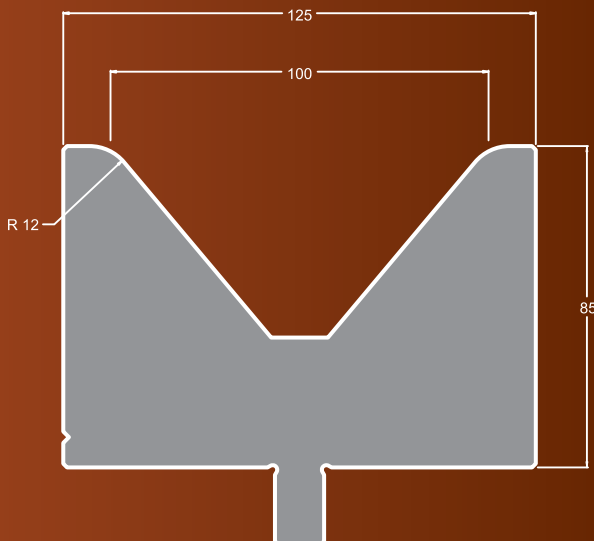

M120. 80° max F kN/m
90°= 3000

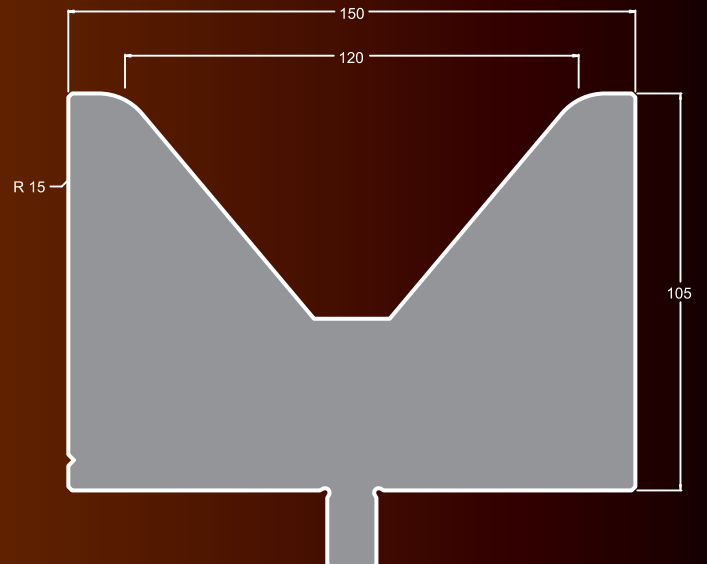

Matrici - Dies - Matrizen (System Bystronic)

M6. 88°
M6. 85° max F kN/m
90°= 900

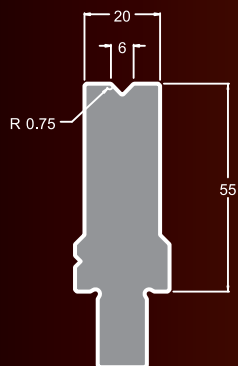

M6S. 88°
M6S. 85° max F kN/m
90°= 900

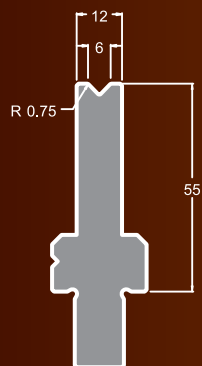

M8. 88°
M8. 85° max F kN/m
90°= 800

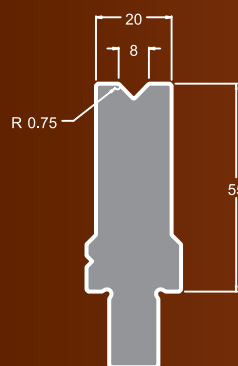

M8S. 88°
M8S. 85° max F kN/m
90°= 800

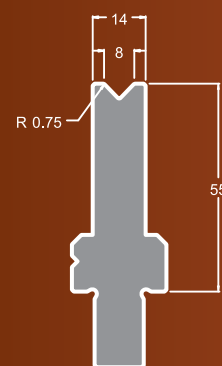

M10. 88°
M10. 85° max F kN/m
90°= 700

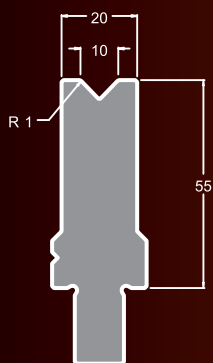

M10S. 88°
M10S. 85° max F kN/m
90°= 700

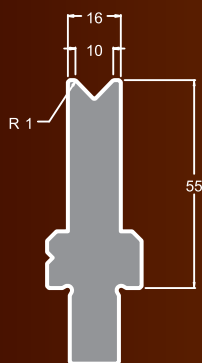

M12. 88°
M12. 85° max F kN/m
90°= 700

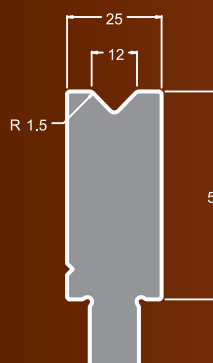

M12S. 88°
M12S. 85° max F kN/m
90°= 700

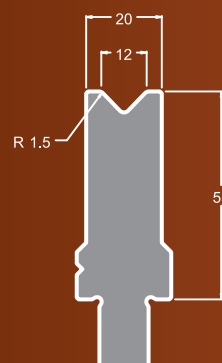

M16. 88°
M16. 85° max F kN/m
90°= 900

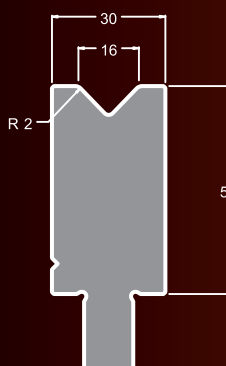

M20. 88°
M20. 85° max F kN/m
90°= 900

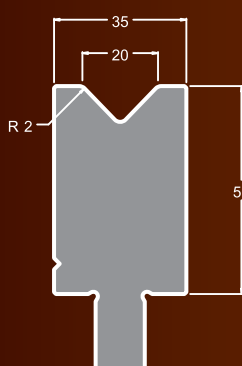

M24. 88°
M24. 85° max F kN/m
90°= 1000

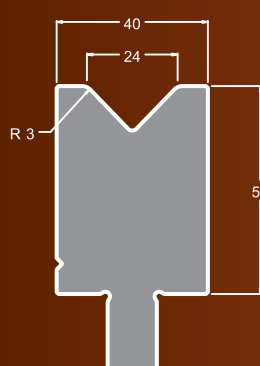

M32. 85° max F kN/m
90°= 1500

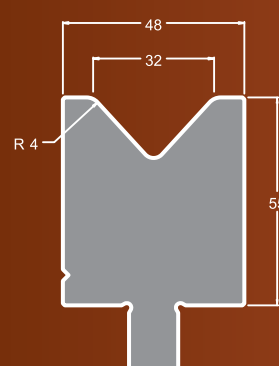

Matrici - Dies - Matrizen (System Bystronic)

Adaptor R-Euro A

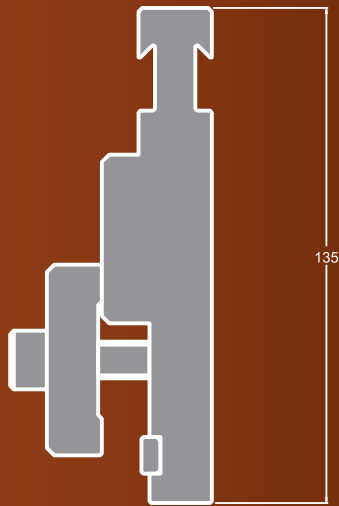

Adaptor R-EuroB

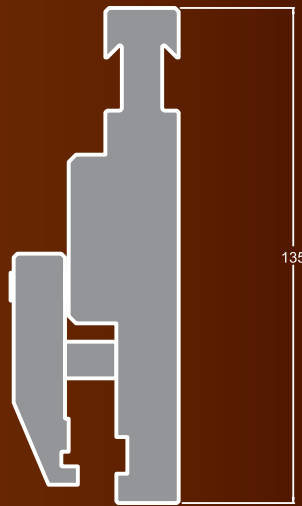

Adaptor R-R

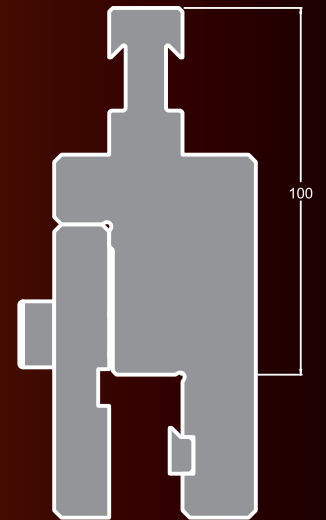

Adaptor R-S

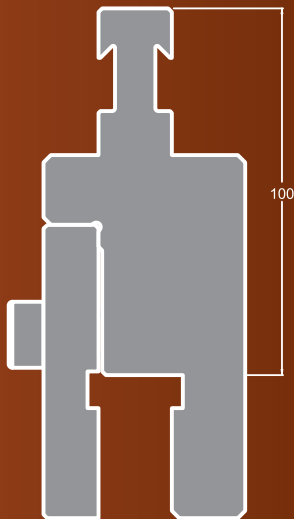

Adaptor R-RFA

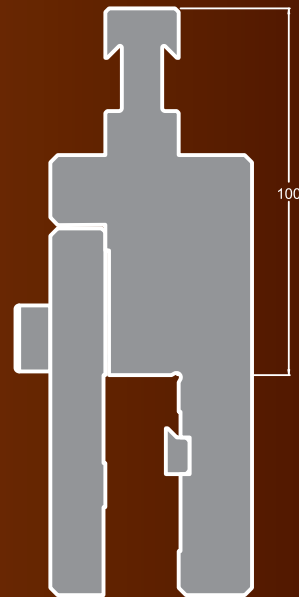

Adaptor RFA-EuroA

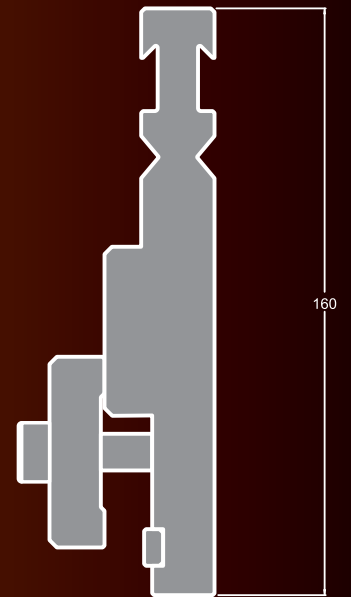

Adaptor RFA-EuroB

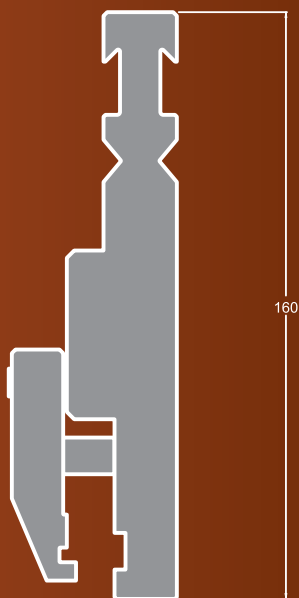

Adaptor RFA-R

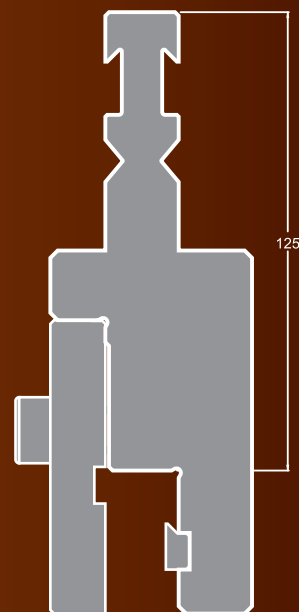

Adaptor RFA-RFA

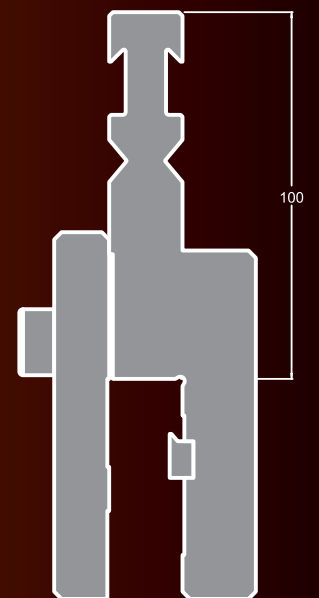



The Spirit of Innovation

Qualità e Precisione
Quality & Precision
Qualität und Präzision

LE SOLUZIONI PIU' AFFIDABILI PER LA TUA AZIENDA.
I TUOI PROBLEMI DI PIEGATURA E ATTREZZAGGIO MACCHINA SONO IL NOSTRO OBIETTIVO.

**FIND THE MORE RELIABLE SOLUTIONS FOR YOUR COMPANY.
YOUR BENDING PROBLEMS AND MACHINE SET-UP ARE OUR GOAL**

WIR FINDEN EINE ZUVERLÄSSIGE LÖSUNG FÜR SIE.
DIE LÖSUNG IHRER ABKANTPROBLEME UND DIE REDUZIERUNG DER RÜSTZEITEN
SIND UNSER ZIEL.

Punzoni/Matrici - Punches/Dies - Stempel/Matrizen (System Colly)



Acciaio 42CrMo4 bonificato a 23-28 Hrc
 42CrMo4 Steel Hard. & Temp. to Hrc 23-28
 42CrMo4 Stahl Vergutet auf Hrc 23-28

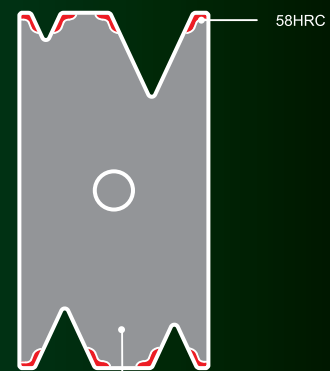
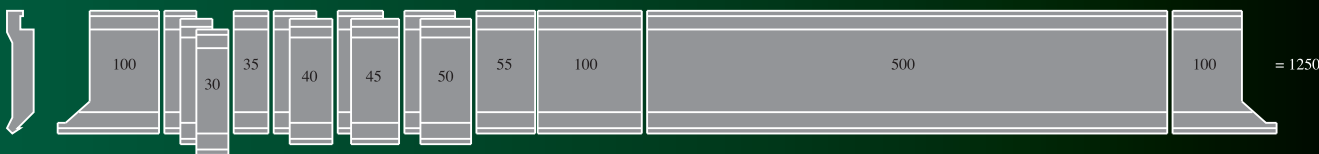
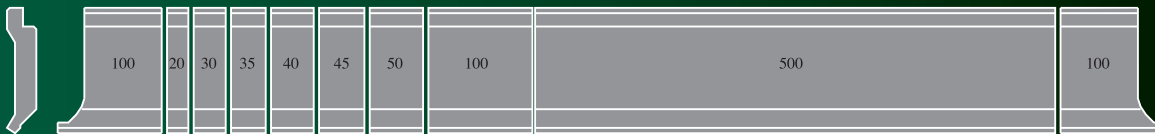

Acciaio 42CrMo4 bonificato a 23-28 Hrc
 42CrMo4 Steel Hard. & Temp. to Hrc 23-28
 42CrMo4 Stahl Vergutet auf Hrc 23-28

- Il nuovo processo di tempra profonda a CNC, è oggi disponibile con profondità minima di 4mm e durezza fino a 58HRC.
- The new CNC-Deeaphardening process, it is now able to consistently harden to Rockwell 58C at depth of 4mm.
- CNC-Deeaphardening ist ein Härtingsverfahren das neulich von Toolspress worden ist für Anwendung bei Abkantwerkzeugen.

Punzoni - Punches - Stempel (System Colly)

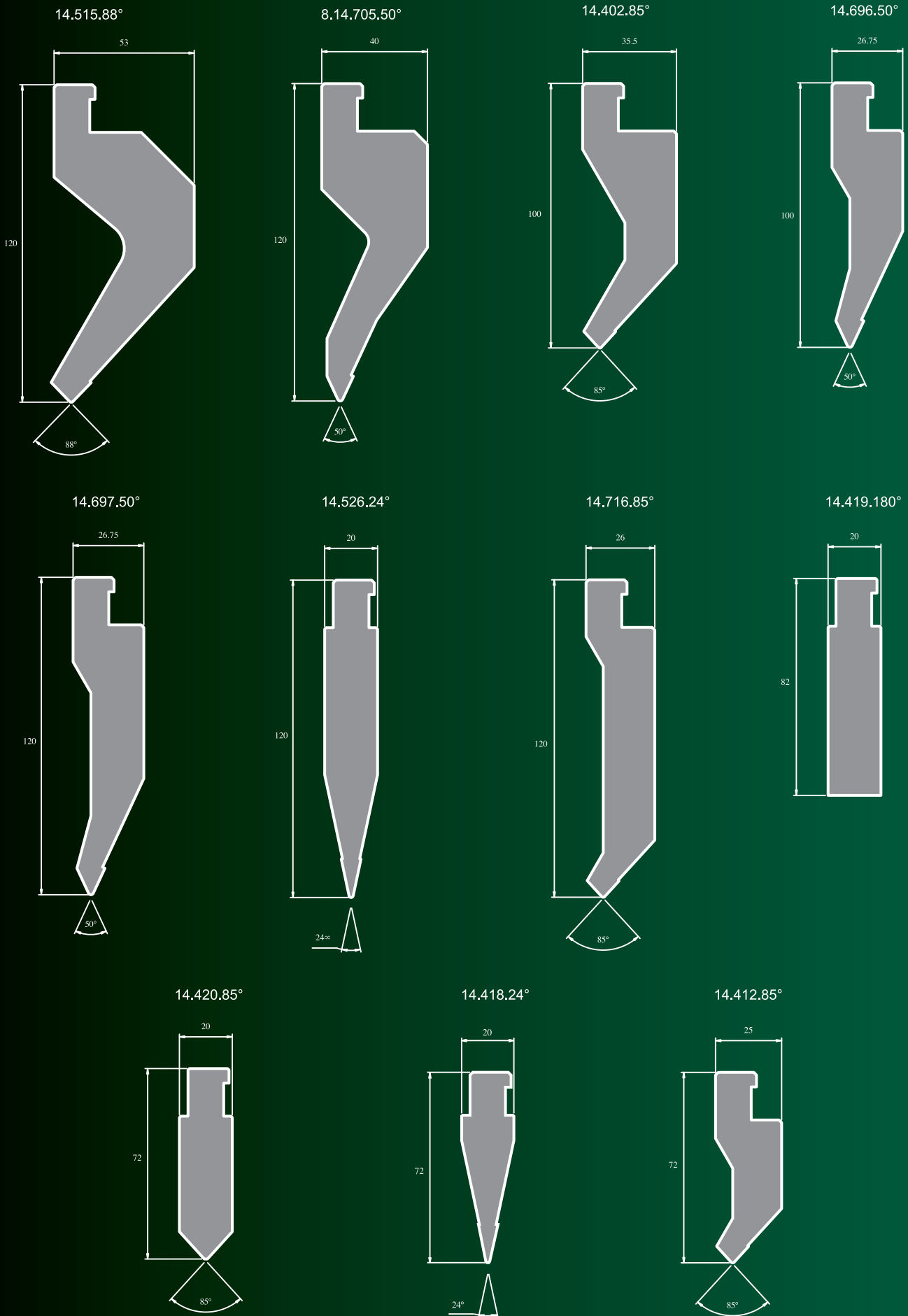

Matrici - Dies - Matrizen (System Colly)

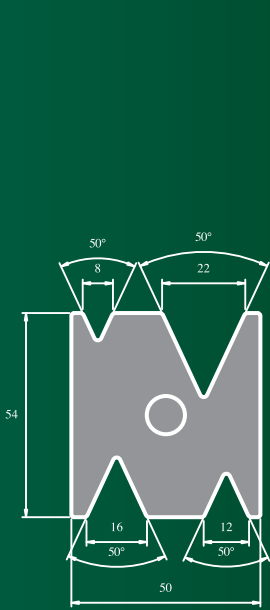

6.14.767



6.14.768

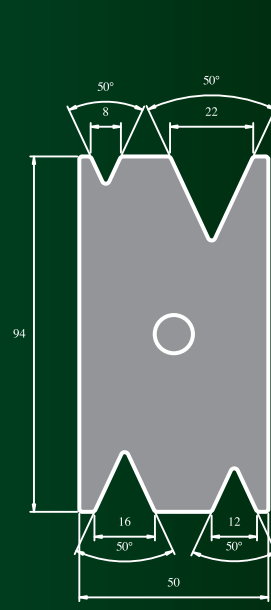

6.14.769

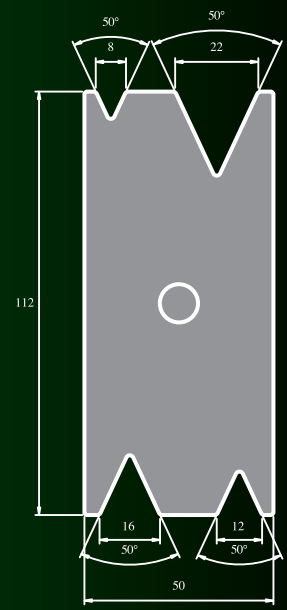

6.14.770

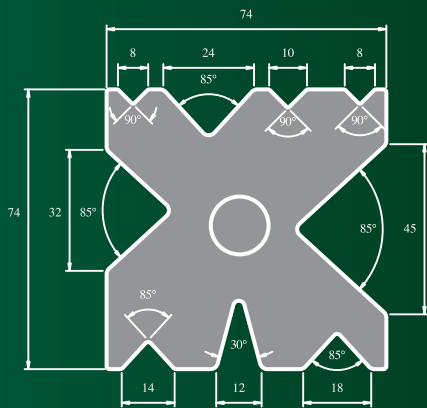

14.318

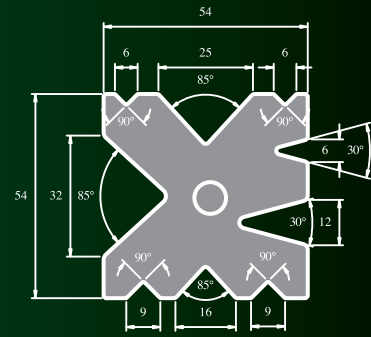

14.319

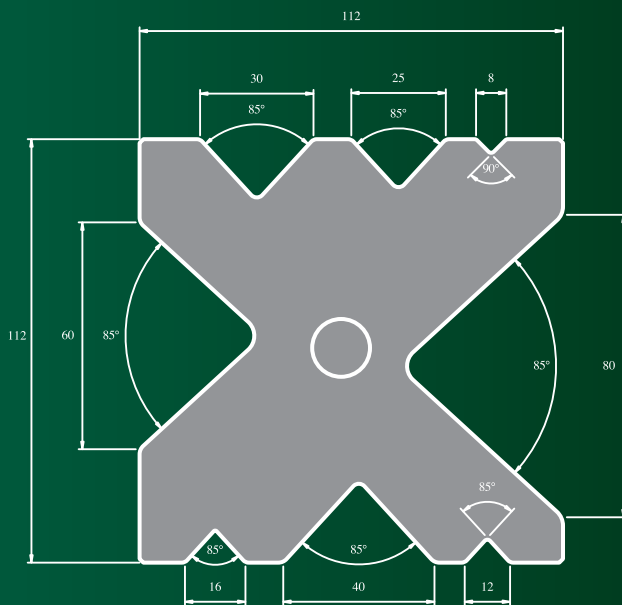

14.518

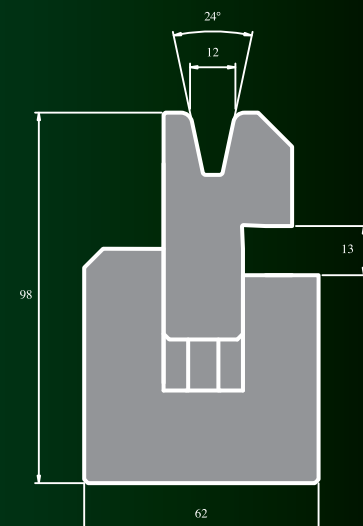

u479 v12

Punzoni - Punches - Stempel (System Trumpf)



Acciaio 42CrMo4 bonificato a 23-28 Hrc
 42CrMo4 Steel Hard. & Temp. to Hrc 23-28
 42CrMo4 Stahl Vergütet auf Hrc 23-28

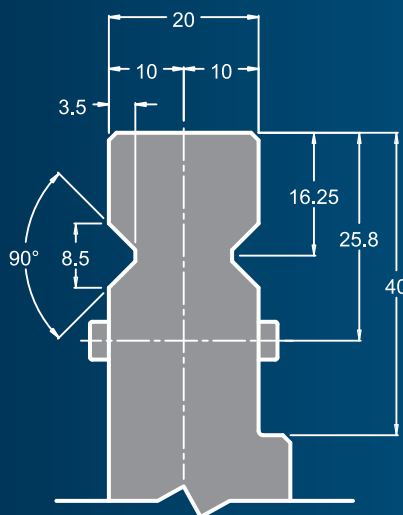

- Il nuovo processo di tempra profonda a CNC, è oggi disponibile con profondità minima di 4mm e durezza fino a 58HRC.
- The new CNC-Deeaphardening process, it is now able to consistently harden to Rockwell 58C at depth of 4mm.
- CNC-Deeaphardening ist ein Härtingsverfahren das neulich von Toolspres worden ist für Anwendung bei Abkantwerkzeugen.



Basic segment 250 mm



Punzoni - Punches - Stempel (System Trumpf)

TOW210. 28° max F kN/m
800

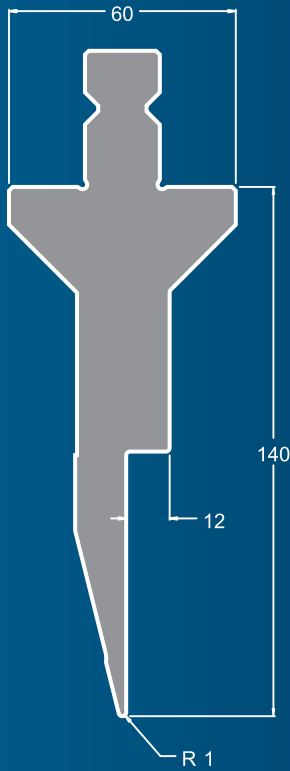

TOW202. 28° max F kN/m
600

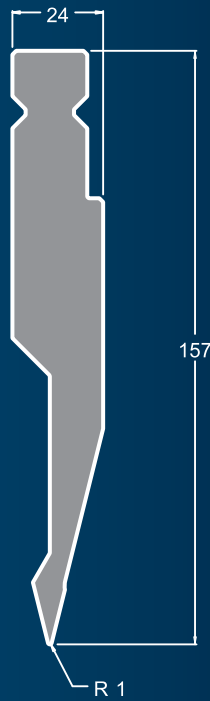

TOW203. 60° max F kN/m
1600

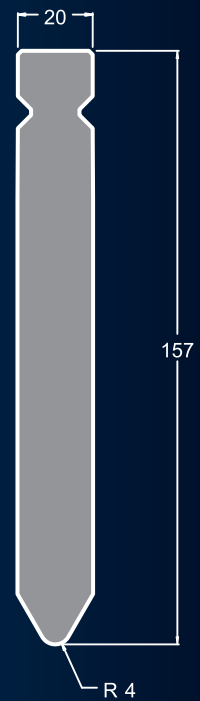

TOW200. 86° max F kN/m
900



TOW201. 86° max F kN/m
900



TOW211. 89° max F kN/m
1600

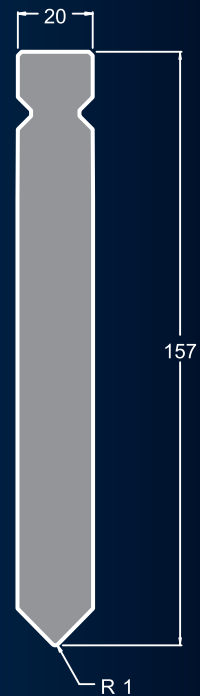

Punzoni - Punches - Stempel (System Trumpf)

TOW201S. 86° max F kN/m
900

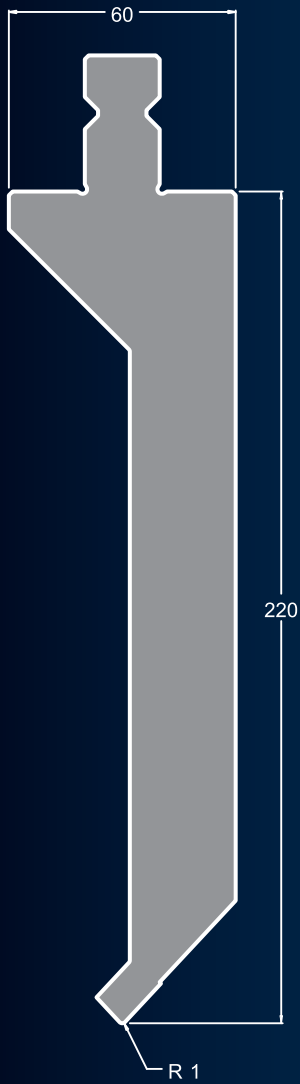

TOW211S. 89° max F kN/m
1600

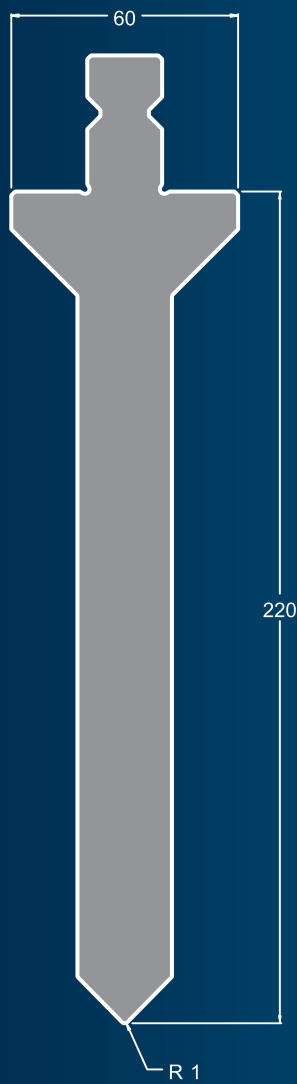

TOW210S. 28° max F kN/m
900

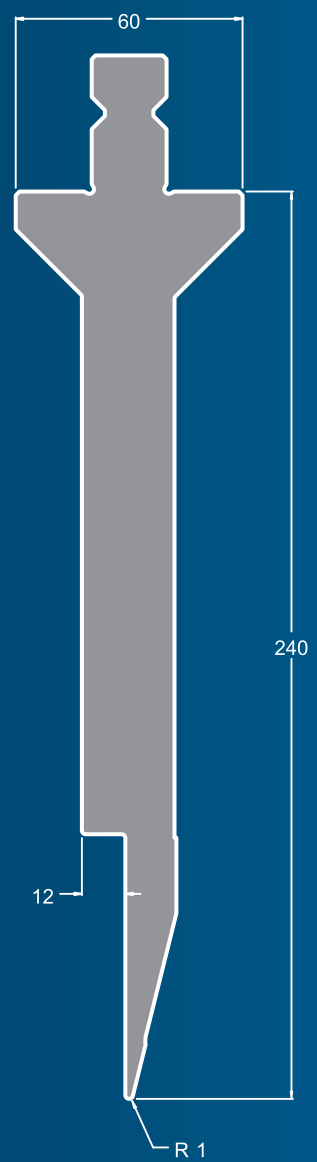

Punzoni - Punches - Stempel (System Trumpf)

TOW202S, 28° max F kN/m
600

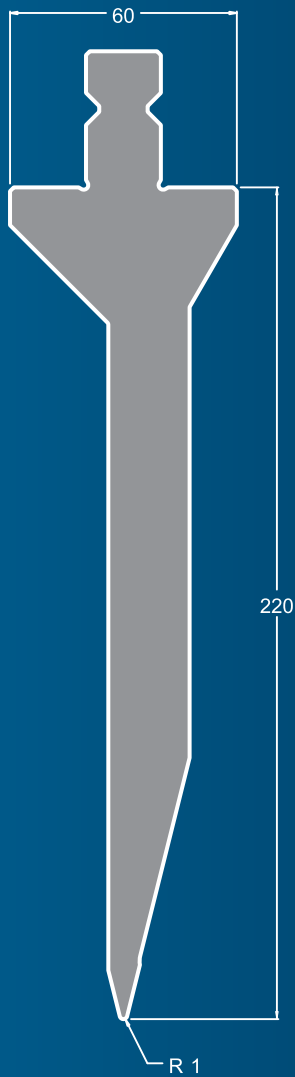

TOW203S, 60° max F kN/m
1600

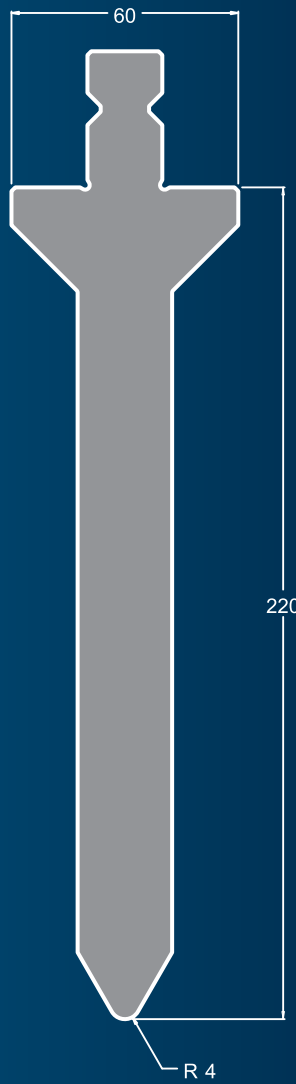

TOW200S, 86° max F kN/m
900

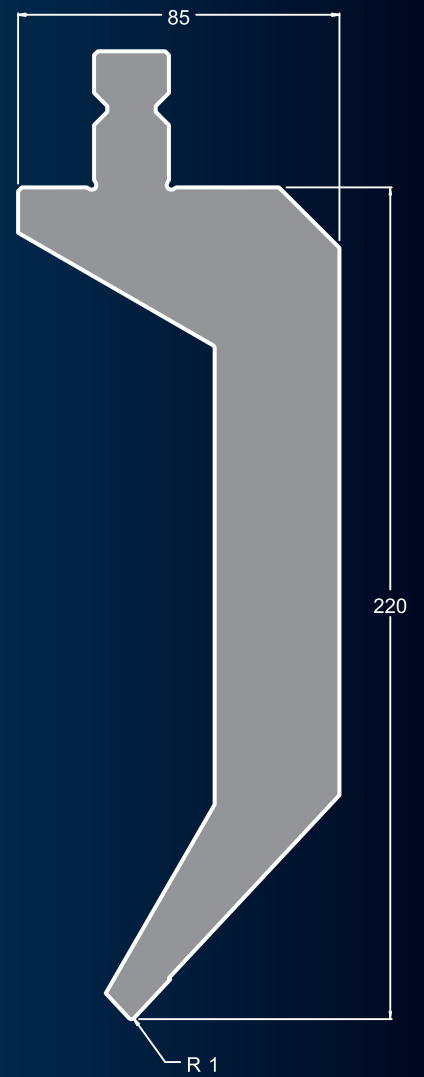

Matrici - Dies - Matrizen (System Trumpf)

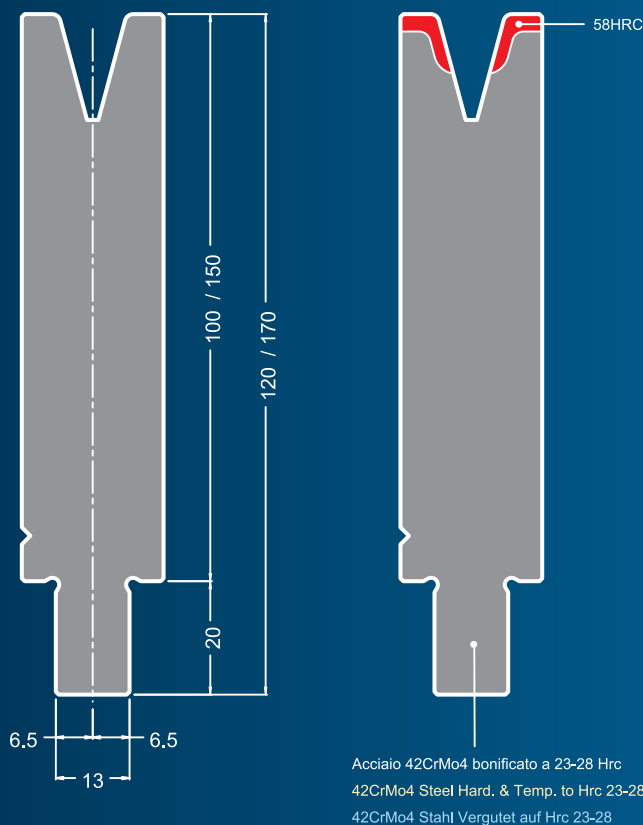

- Il nuovo processo di tempra profonda a CNC, è oggi disponibile con profondità minima di 4mm e durezza fino a 58HRC.
- The new CNC-Deephardening process, it is now able to consistently harden to Rockwell 58C at depth of 4mm.
- CNC-Deephardening ist ein Härtingsverfahren das neulich von Toolspress worden ist für Anwendung bei Abkantwerkzeugen.

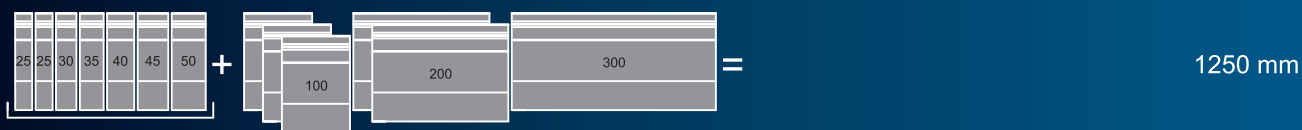

Basic segment 250 mm



Matrici - Dies - Matrizen (System Trumpf)

T06. 30° max F kN/m
 90°= 900
 60°= 600
 30°= 400



T06S. 30° max F kN/m
 90°= 900
 60°= 600
 30°= 400

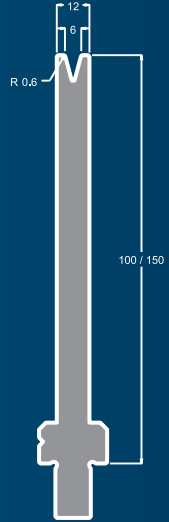

T08. 30° max F kN/m
 90°= 800
 60°= 400
 30°= 200

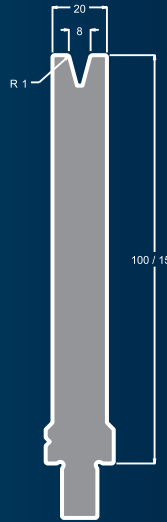

T08S. 30° max F kN/m
 90°= 800
 60°= 400
 30°= 200

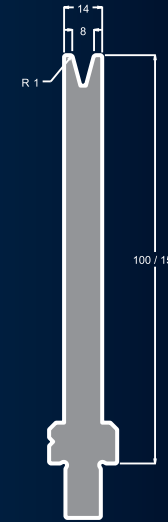

T10. 30° max F kN/m
 90°= 700
 60°= 400
 30°= 150

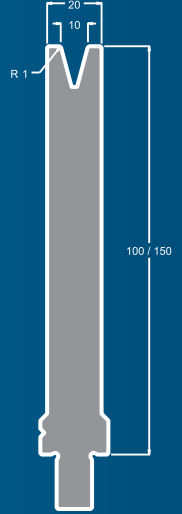

T10S. 30° max F kN/m
 90°= 700
 60°= 400
 30°= 150

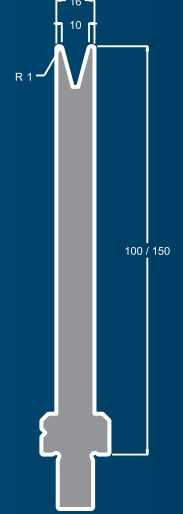

T12. 30° max F kN/m
 90°= 700
 60°= 420
 30°= 200

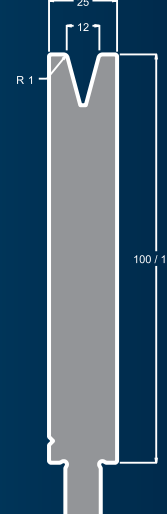

T12S. 30° max F kN/m
 90°= 700
 60°= 420
 30°= 200

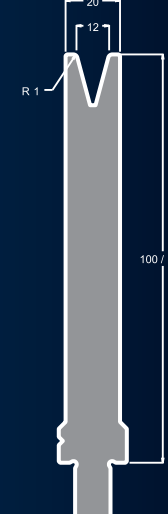

T16. 30° max F kN/m
 90°= 900
 60°= 550
 30°= 200

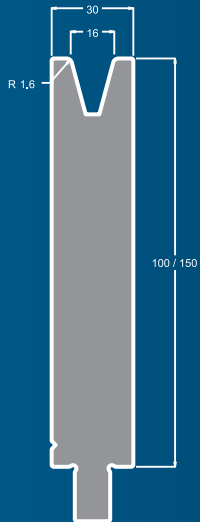

T20. 30° max F kN/m
 90°= 950
 60°= 600
 30°= 200

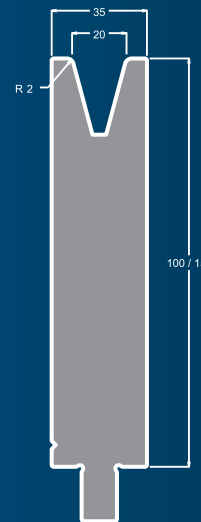

T24. 30° max F kN/m
 90°= 1000
 60°= 600
 30°= 200

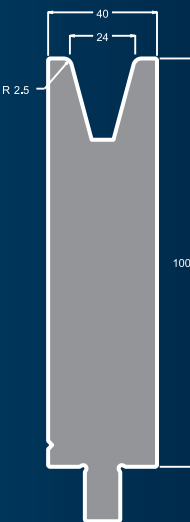

T32. 30° max F kN/m
 90°= 1500
 60°= 700
 30°= 500

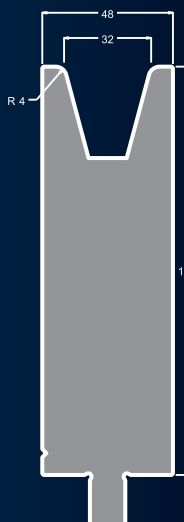

Matrici - Dies - Matrizen (System Trumpf)

T40. 60° max F kN/m
 $\frac{90^\circ}{60^\circ} = 1600$
 $\frac{90^\circ}{60^\circ} = 1300$

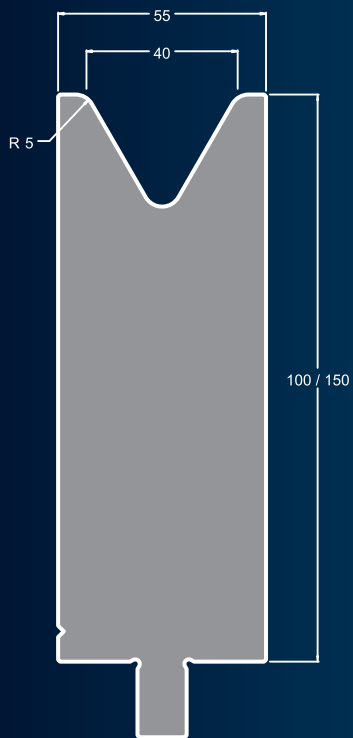

T50. 60° max F kN/m
 $\frac{90^\circ}{60^\circ} = 1700$
 $\frac{90^\circ}{60^\circ} = 1200$

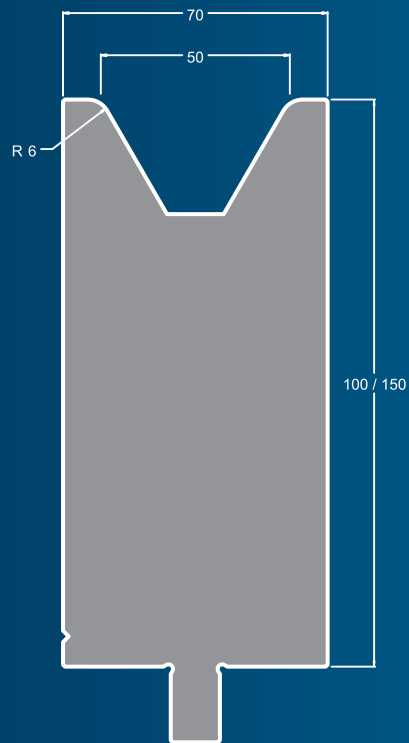

T60. 60° max F kN/m
 $\frac{90^\circ}{60^\circ} = 1800$
 $\frac{90^\circ}{60^\circ} = 1100$

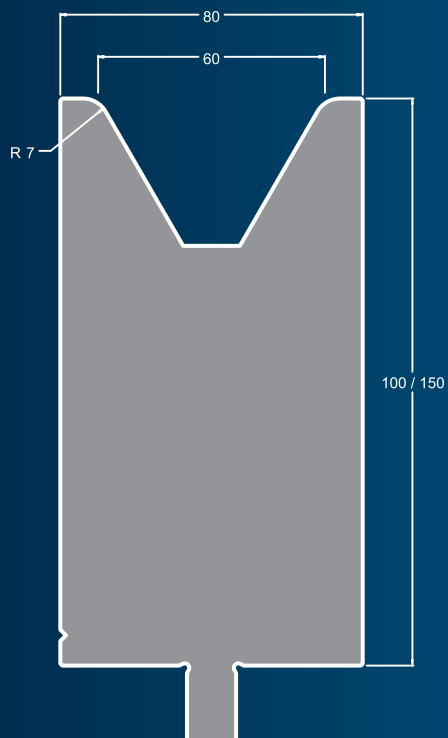

Matrici - Dies - Matrizen (System Trumpf)

T80. 80° $\frac{\text{max F kN/m}}{90^\circ = 1700}$

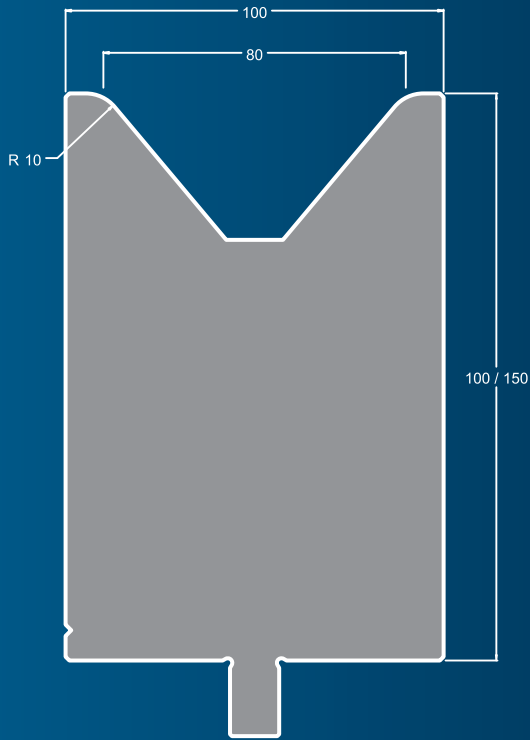

T100. 80° $\frac{\text{max F kN/m}}{90^\circ = 2300}$

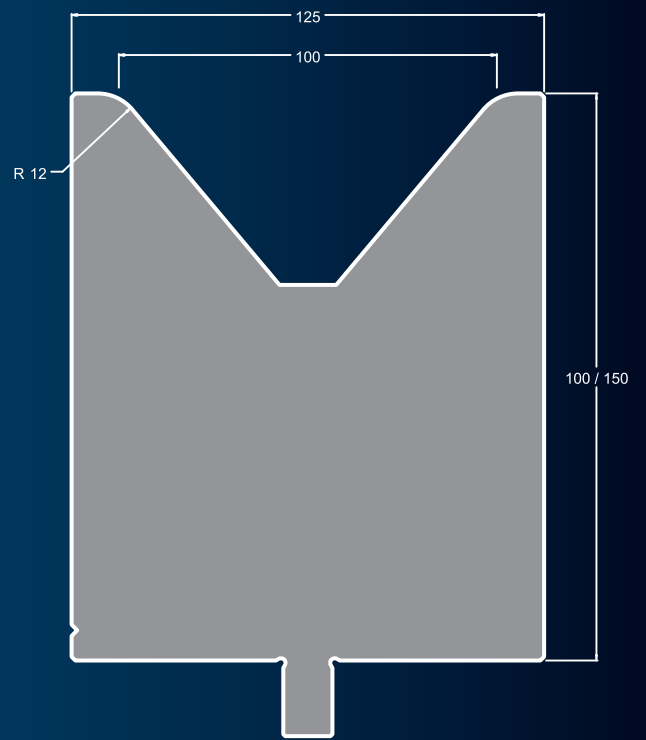

T120. 80° $\frac{\text{max F kN/m}}{90^\circ = 3000}$

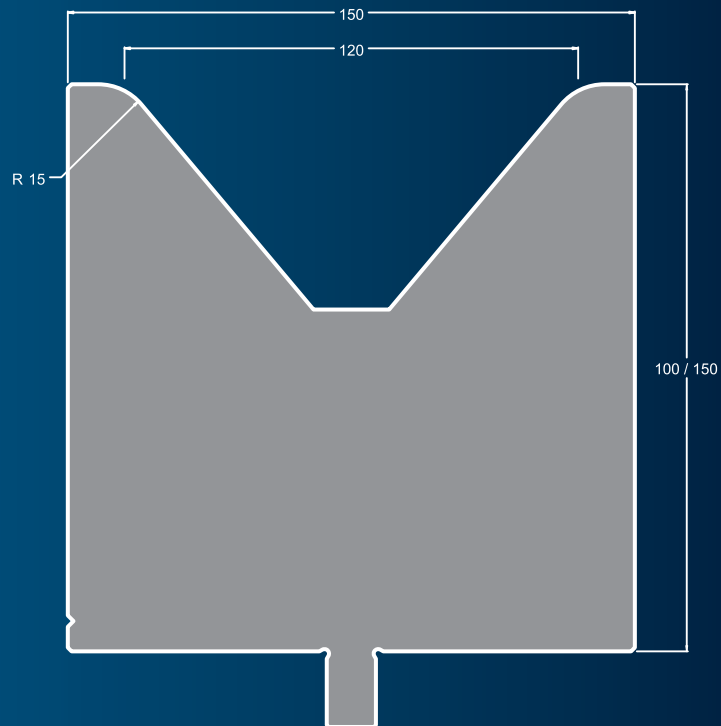

Matrici - Dies - Matrizen (System Trumpf)

T06. 86° max F kN/m
90°= 900

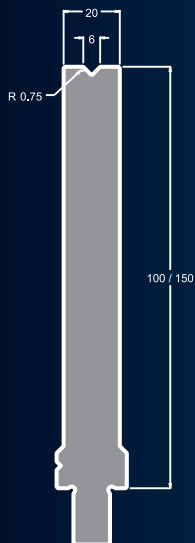

T06S. 86° max F kN/m
90°= 900

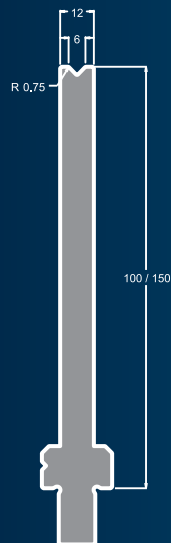

T08. 86° max F kN/m
90°= 800

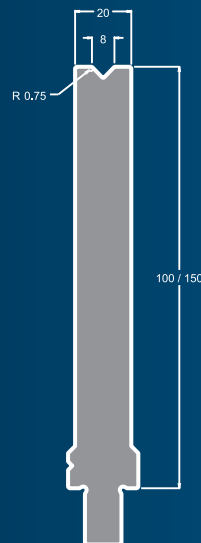

T08S. 86° max F kN/m
90°= 800

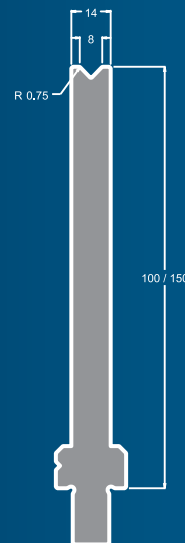

T10. 86° max F kN/m
90°= 700



T10S. 86° max F kN/m
90°= 700

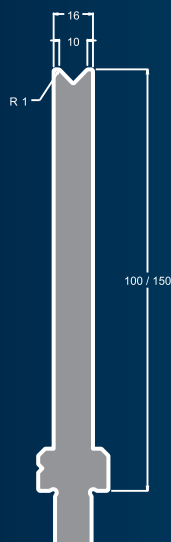

T12. 86° max F kN/m
90°= 700



T12S. 86° max F kN/m
90°= 700

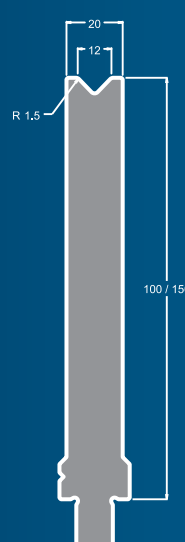

T16. 86° max F kN/m
90°= 900

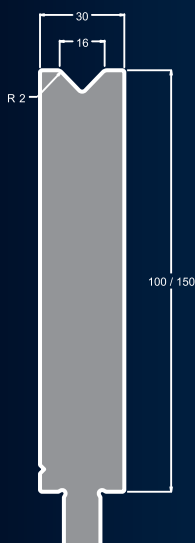

T20. 86° max F kN/m
90°= 950



T24. 86° max F kN/m
90°= 1000

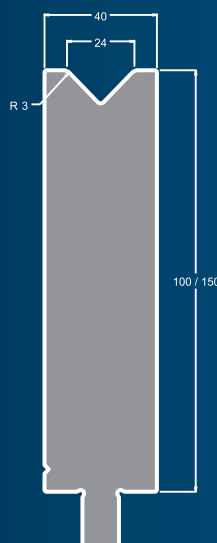

T32. 86° max F kN/m
90°= 1500

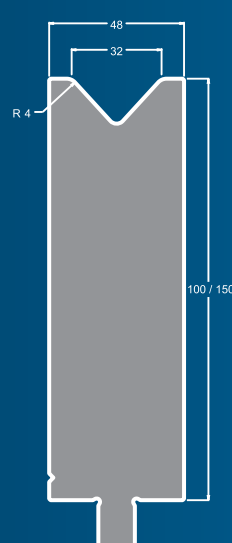

Punzoni - Punches - Stempel (System LVD)



Acciaio 42CrMo4 bonificato a 23-28 Hrc
 42CrMo4 Steel Hard. & Temp. to Hrc 23-28
 42CrMo4 Stahl Vergutet auf Hrc 23-28

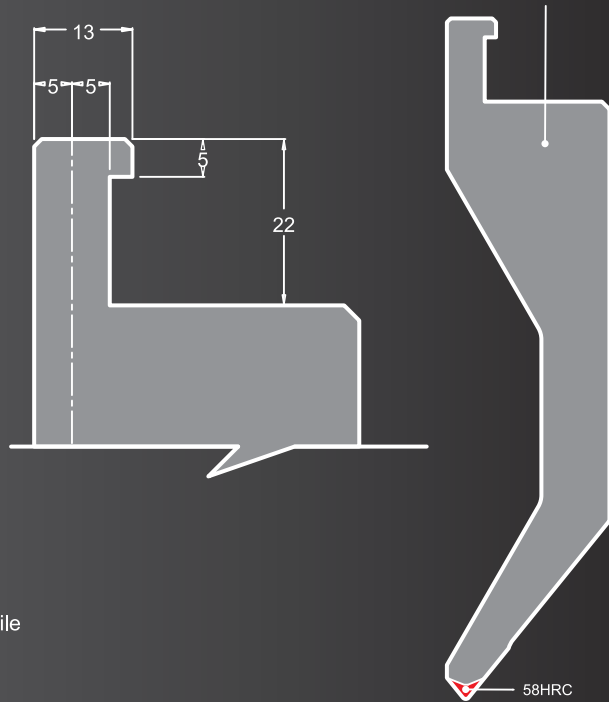

- Il nuovo processo di tempra profonda a CNC, è oggi disponibile con profondità minima di 4mm e durezza fino a 58HRC.
- The new CNC-Dee-phardening process, it is now able to consistently harden to Rockwell 58C at depth of 4mm.
- CNC-Dee-phardening ist ein Härtingsverfahren das neulich von Toolspres worden ist für Anwendung bei Abkantwerkzeugen.

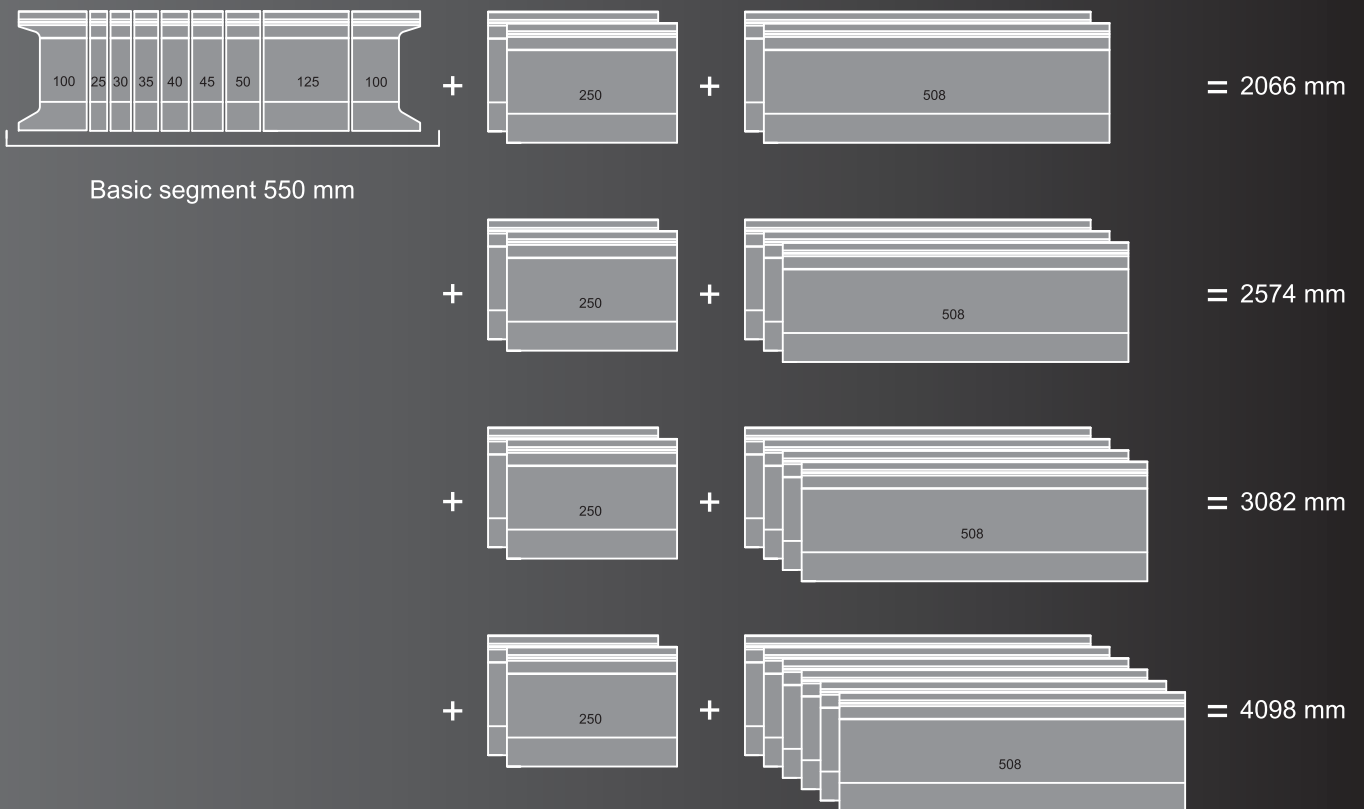

Punzoni - Punches - Stempel (System LVD)

LPC. 78° max F kN/m
700

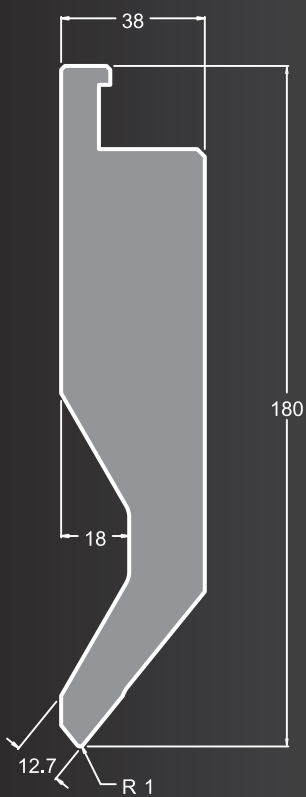

LPD. 78° max F kN/m
450

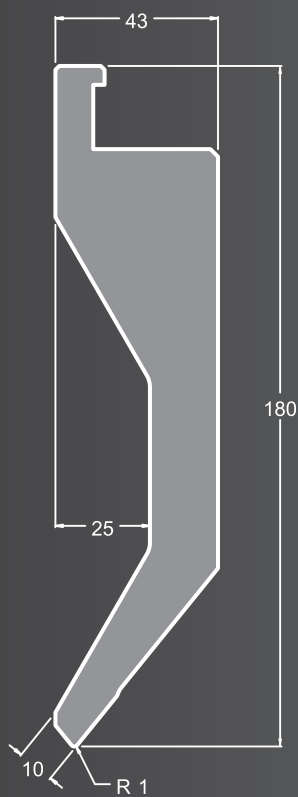

LPE. 78° max F kN/m
400

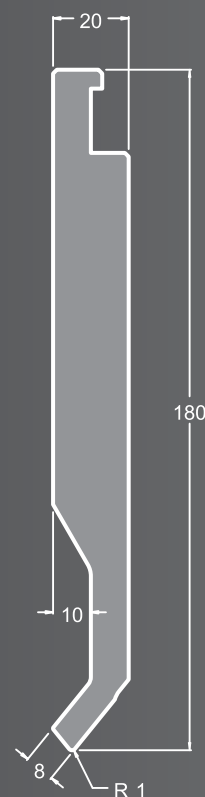

LPF. 26° max F kN/m
500

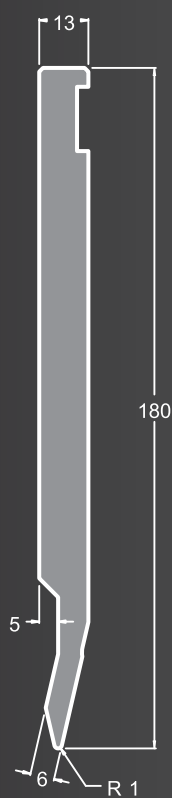

LPR. 78° max F kN/m
1000

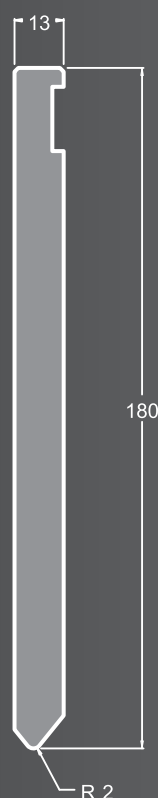

Matrici - Dies - Matrizen (System LVD)

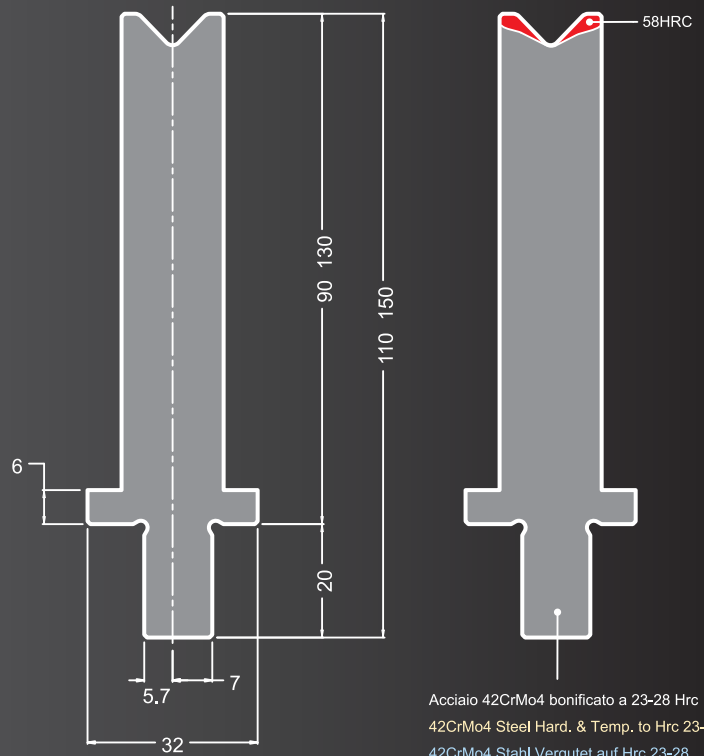

- Il nuovo processo di tempra profonda a CNC, è oggi disponibile con profondità minima di 4mm e durezza fino a 58HRC.
- The new CNC-Deephardening process, it is now able to consistently harden to Rockwell 58C at depth of 4mm.
- CNC-Deephardening ist ein Härtingsverfahren das neulich von Toolspres worden ist für Anwendung bei Abkantwerkzeugen.

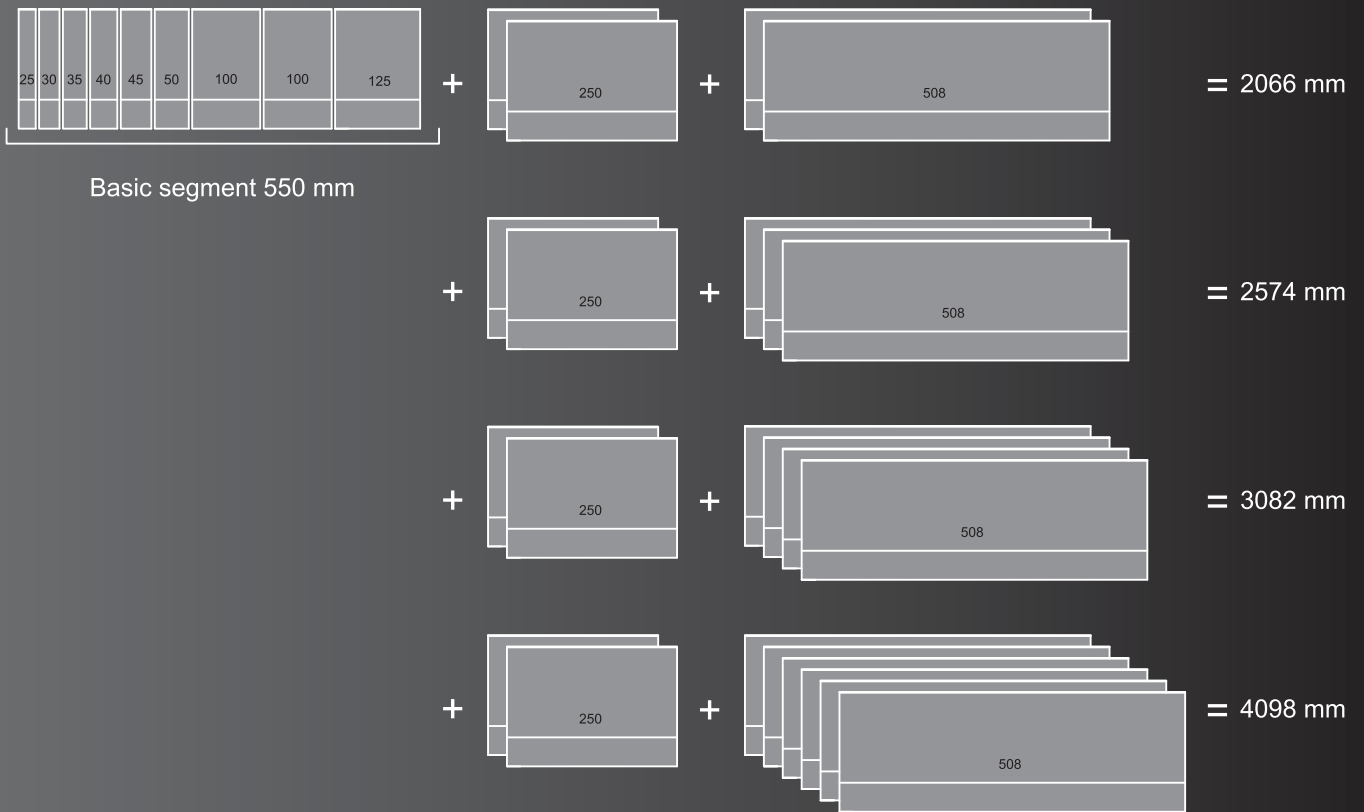

Matrici - Dies - Matrizen (System LVD)

LM6. 30° max F kN/m
 90°= 800
 60°= 400
 30°= 200



LM8. 30° max F kN/m
 90°= 800
 60°= 400
 30°= 200

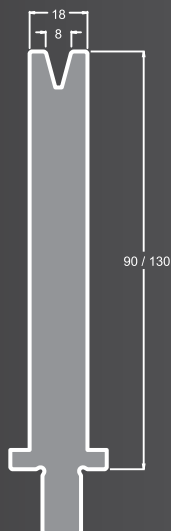

LM10. 30° max F kN/m
 90°= 850
 60°= 500
 30°= 300

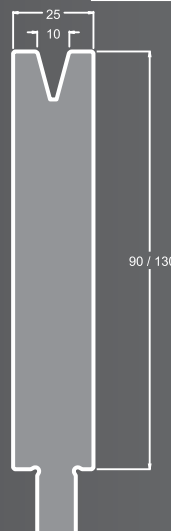

LM12. 30° max F kN/m
 90°= 900
 60°= 600
 30°= 400

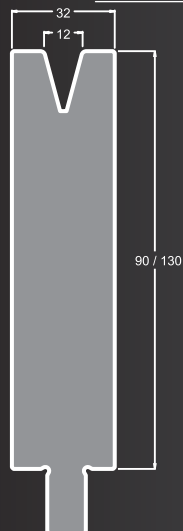

LM16. 30° max F kN/m
 90°= 900
 60°= 600
 30°= 400

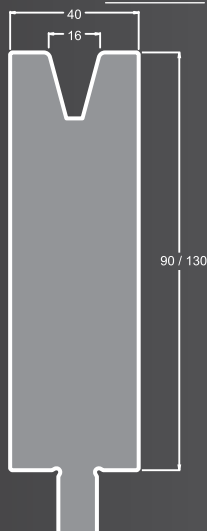

LM24. 30° max F kN/m
 90°= 1500
 60°= 700
 30°= 500

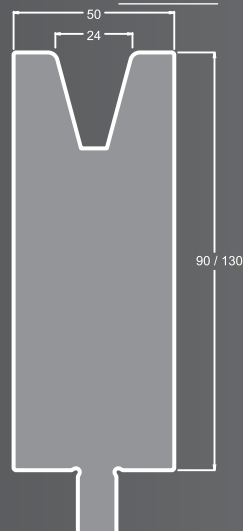

LM6. 78° max F kN/m
 90°= 400

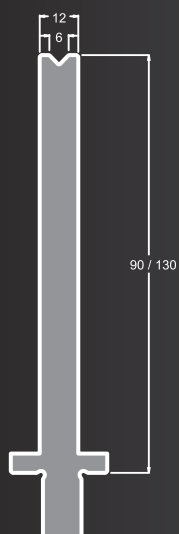

LM8. 78° max F kN/m
 90°= 400

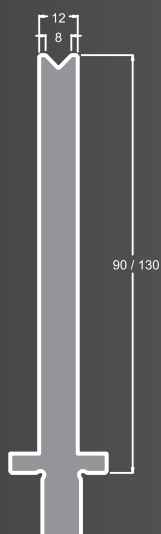

LM10. 78° max F kN/m
 90°= 500

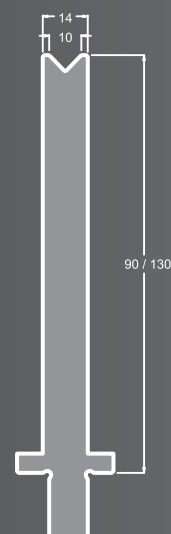

Matrici - Dies - Matrizen (System LVD)

LM12. 78° max F kN/m
90°= 600

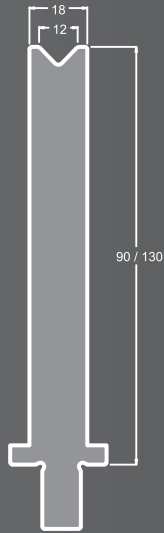

LM16. 78° max F kN/m
90°= 800



LM20. 78° max F kN/m
90°= 1000

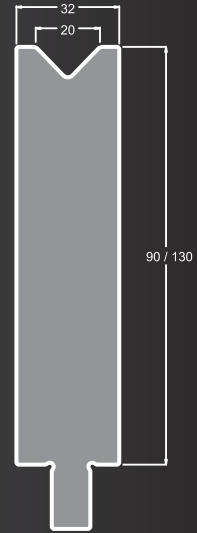

LM24. 78° max F kN/m
90°= 1000

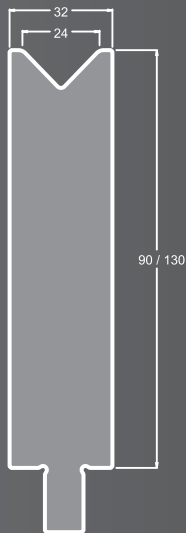

LM30. 78° max F kN/m
90°= 1100

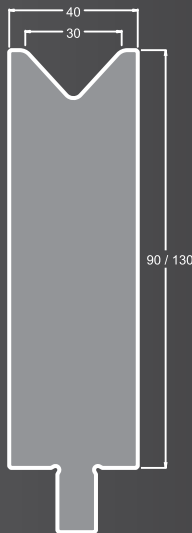

LM40. 78° max F kN/m
90°= 1300

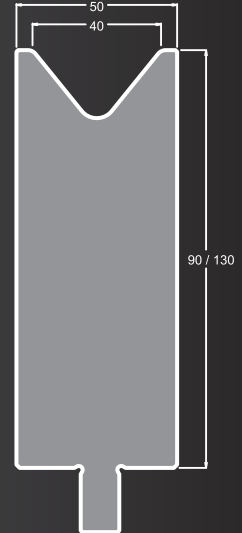

LM50. 78° max F kN/m
90°= 1500

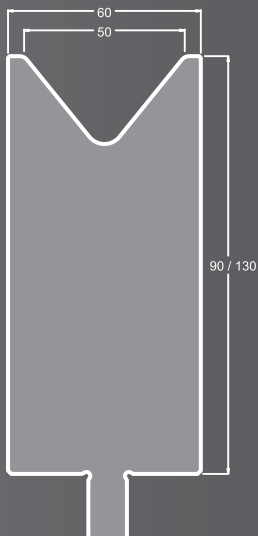

LM60. 78° max F kN/m
90°= 1500

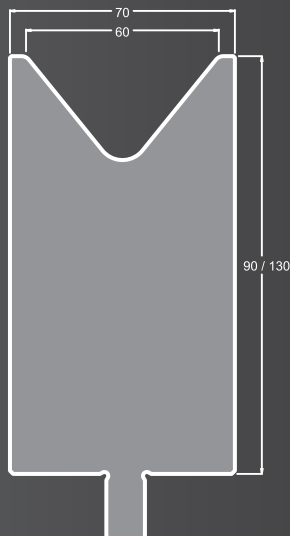

LM70. 78° max F kN/m
90°= 1500



TABELLA DI PIEGATURA IN ARIA

AIR BENDING FORCE CHART

PRESSKRAFTTABELLE

S	6	8	10	12	16	20	25	32	40	50	63	80	100	125	160	200	250	320	400	500	630	V	
Spessore mm	4	5,5	7	8,5	11	14	17,5	22	28	35	45	55	71	89	113	140	175	226	280	350	450	B	
	1	1,3	1,6	2	2,6	3,3	4	5	6,5	8	10	13	16	20	26	33	41	53	65	83	100	Ri	
0,6	4	4																					
0,8	7	5	4																				
1	11	8	7	6																			
1,2	16	12	10	8	6																		
1,5		17	15	13	9	8																	
2			27	22	17	13	11																
2,5				35	26	21	17	13															
3					38	30	24	19	15														
4						54	42	34	27	21													
5							67	52	42	33	26												
6								75	60	48	38	30											
8									107	85	68	53	43										
10										134	105	85	67	53									
12												120	96	78	60								
15													150	120	95	75							
20														215	170	135	108	85					
25															265	210	170	130	105				
30																300	240	190	150	120			
40																	430	340	270	215			
50																		525	420	340	270		t/m

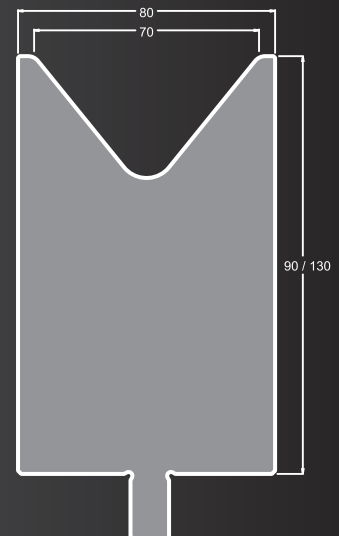
F

La tabella di piegatura qui sopra raffigurata e basata su acciaio medio con resistenza di 45-50 chilogrammi per millimetro quadrato. Per calcolare la forza approssimativa di piegatura richiesta per piegare altri tipi di materiale utilizzare il fattore di moltiplicazione qui sotto indicato. I valori indicati nelle tabelle sono validi per pieghe a 90°. In caso di pieghe a 30°, la capacità di Massimo carico si riduce.

The bending force (tonnage) figures listed above are based on mild steel with a tensile strength of 45/50 kilograms per square millimeter. To calculate the approximate bending force (tonnage) requirements of others materials, please use the multipliers listed. The mentioned values are valid for 90° bending. At coining with 30° degree, the max loading capacity is reduced.

Die oben angegebene Abkantkraft (Ton.) gilt für Normalstahl mit einer Zugfestigkeit von 45-50 kg/mm². Um die entsprechende Abkantkraft für andere Materialien zu berechnen, benutzen Sie bitte die angegebenen Multiplikatoren. Die angegebenen Werte sind das Biegen für 90° gültig. Beim Prägen mit 30° Matrizen ist die max. Belastbarkeit reduziert.

Formula Standard per selezionare l'apertura del "V"
Standard formulas as for selecting a V-opening
Standardformel zur festlegung der V-Öffnung

Spessore materiale (mm) Material thickness (mm) Blechedicke (mm)	0.5 - 2.5	3.0 - 8	9 - 10	12 - 30
Larghezza V V - opening V - Öffnung	S x 6	S x 8	S x 10	S x 12

S = Spessore del materiale 45Kg/m²
F = Forza per 1 metro (Ton/Mt)
IR= Raggio interno di piegatura (mm)
B = Lunghezza bordo minimo (mm)
V = Larghezza del V (mm)

Ottone dolce Soft Brass Weiches Messing	Ton x mt x 50%
Alluminio dolce Soft Aluminium Weiches Aluminium	Ton x mt x 50%
Lega di Alluminio trattato Heat Treated Aluminium Alloy Wärmebehandelte Alminiumlegierung	Ton x mt x 150%
Acciaio Inox Stainless Steel Rostfreier Stahl	Ton x mt x 150%

S = Material thickness (45Kg/m²)
F = Force per meter (Ton/Mt)
IR= Inside Radius (mm)
B = Minimum Hang lenght (mm)
V = V - Opening (mm)

S = Blechedicke in mm:
Zugfestigkeit ca. 45Kg/m²
F = Enforderliche Press Kraft (Ton/Mt)
IR= Produktinnenradius (mm)
B = Kürzeste Schenkellänge (mm)
V = V - Öffnung (mm)

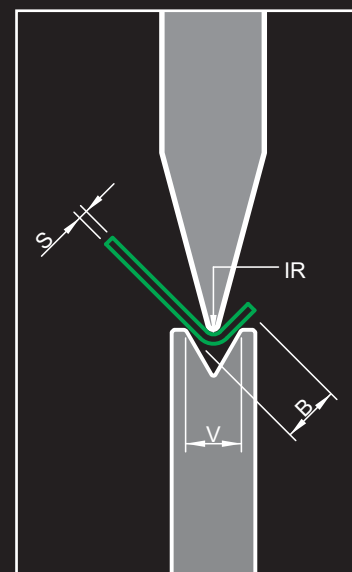

TOOLSPRESS IN THE WORLD



Tp Tooling srl - Via Argini, 23 - S. Maria del Piano - 43037 Lesignano de' Bagni - Parma - ITALY
Tel: ++39 0521 850510 r.a. - Fax: ++39 0521 850796
E-mail: sales@toolspress.com

www.toolspress.com